

FEEDING DUAL LOUDSPEAKER SYSTEMS

MONTHLY  
ONE SHILLING

The  
**Wireless  
World**

*COVERING  
EVERY WIRELESS INTEREST*

APRIL, 1941

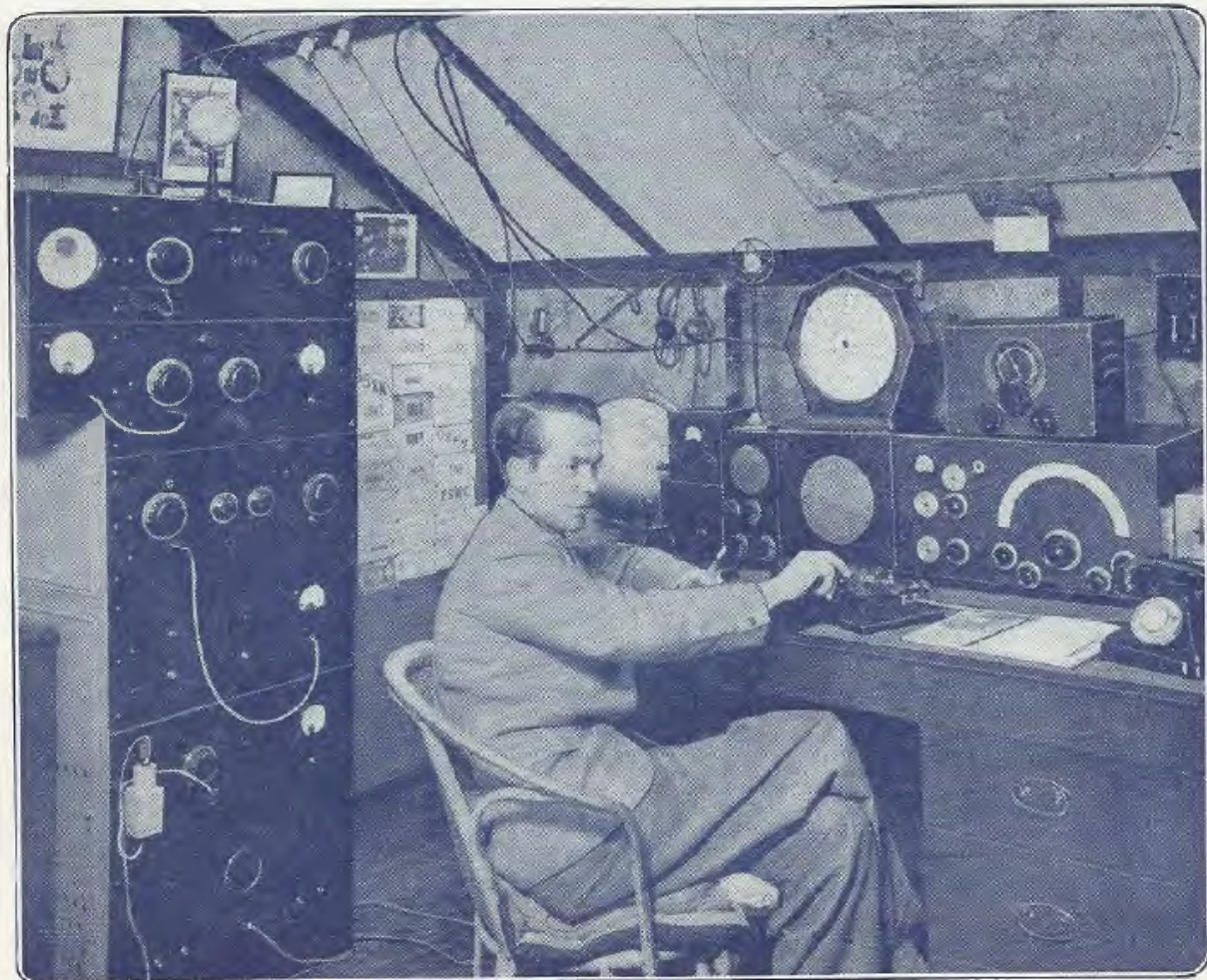

THOUGHTS ON POST-WAR AMATEUR TRANSMISSION



# CERAMIC COIL FORMERS

...FOR GREATER  
RADIO EFFICIENCY



**Outstanding advantages:**  
CERAMIC MATERIAL PROVIDES FOR  
GREATER ACCURACY OF WORKING.  
UNAFFFECTED BY TEMPERATURE AND  
HUMIDITY.  
COMPLETE STABILITY.

Write for details.

CONTRACTORS TO G.P.O. AND GOVERNMENT DEPARTMENTS.  
ON A.I.D. APPROVED LIST.

## UNITED INSULATOR CO LTD

*The Pioneers of Low Loss Ceramics*

12-16 LAYSTALL STREET  
LONDON. E.C.1

Tel: TERMINUS 4118-9

Grams: CALANEL, SMITH, LONDON

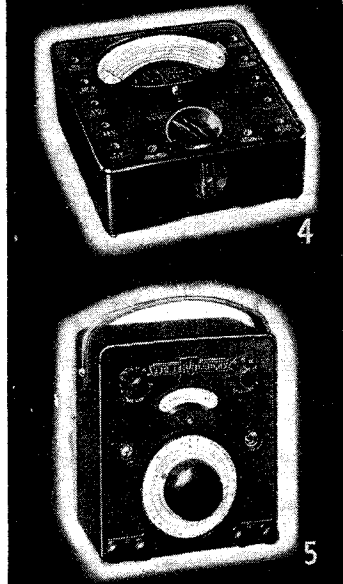
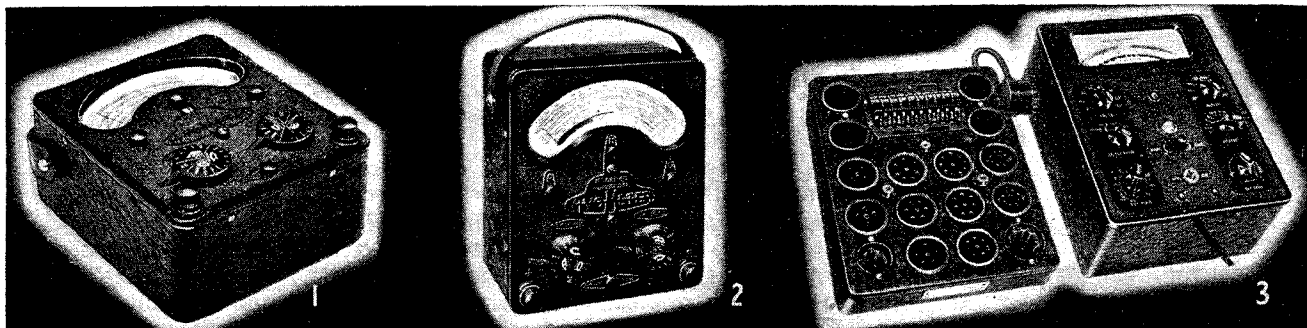

## ELECTRICAL MEASURING INSTRUMENTS

BRITISH MADE

THE world-famous range of "AVO" Instruments is the outcome of many years of intensive research and experience in designing and producing high-grade electrical testing equipment. To-day, the word "Avo" is synonymous with simplicity, versatility and absolute accuracy. In the comprehensive "AVO" range there is an instrument to meet every electrical testing need of both expert and experimenter.

Write for fully descriptive literature dealing with any instrument in which you are interested, and for current prices.

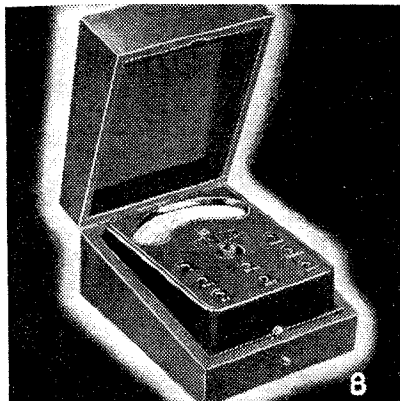

1. 46-range Model 7 Universal AvoMeter.
2. 40-range Model 40 Universal AvoMeter.
3. "Avo" Valve Tester.
4. Universal AvoMinor.
5. "Avo" Test Bridge.
7. All-wave "Avo" Oscillator.
8. D.C. AvoMinor.

Other "Avo" Instruments :

- "Avo" Bonding Meter.
- "Avo" Milliohm-meter.
- High Resistance AvoMinor.
- "Avo" Low Resistance Ohmmeter.
- The AvoDapter.
- 9-pin AvoCoupler.

# PRECISION METERS

that Master every Testing Problem

Sole Proprietors and Manufacturers:

THE AUTOMATIC COIL WINDER & ELECTRICAL EQUIPMENT CO. LTD., Winder House, Douglas St., London, S.W.1. Telephone . Victoria 3404/7.

# RAYMART Variable Condensers

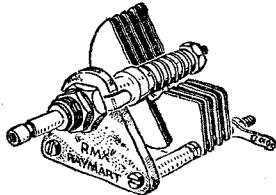

Our range of micro-variables has been considerably extended owing to the heavy demand of the Government Services, Aircraft Radio Manufacturers, etc. Two types are manufactured, differing only in physical size. All have the features which have made our range of micro-variables famous—all-brass construction, heavy gauge vanes, ball-bearing spindle, entirely obviating end and side-play with an electrical shorting device which short-circuits the ball-race. Ceramic insulation (RMX, the latest product of the laboratories—its high frequency performance being well known).

It should be noted that all parts of these condensers are turned from the solid bar, no drawn rod being used. This gives a precision and accuracy unobtainable in competitive types. The following tables of particulars will help you to choose suitable types :

### STANDARD (VCX) SERIES

TYPE	Max. Cap. in mmfd. approx.	Min. Cap. in mmfd. approx.	Spacing of adjacent Rotor or Stator Vanes	No. of Rotor Vanes	No. of Stator Vanes	Overall Length	Depth behind Panel	PRICE
VC15X	15	2.5	.070	1	1	2.27"	1.5"	1/9
VC40X	40	2.75	.070	2	2	2.3"	1.5"	2/-
VC100X	100	3.8	.070	5	4	2.7"	1.8"	2/3
VC160X	160	6.0	.070	7	6	2.97"	2.07"	2/6
VC250X	250	7.3	.070	11	11	3.25"	2.35"	3/-
VC20D	20	4.0	.140	2	3	2.5"	1.55"	2/9
NC15	15	3.0	.210	1	2	2.4"	1.55"	2/9
TC40	40	6.0	.210	6	5	3.35"	2.55"	3/6

### MIDGET (MCX) SERIES

TYPE	Max. Cap. in mmfd. approx.	Min. Cap. in mmfd. approx.	Spacing of adjacent Rotor or Stator Vanes	No. of Rotor Vanes	No. of Stator Vanes	Overall Length	Depth behind Panel	PRICE
MC15X	13.5	3.0	.070	1	2	2.35"	1.3"	1/10
MC60X	58	5.0	.070	6	5	2.8"	1.7"	2/1
MCI20X	124	8.0	.070	12	11	3.35"	2.25"	2/5
MC5DX	5	3.0	.140	1	1	2.35"	1.3"	1/10
MCI5DX	15	5.0	.140	3	3	2.7"	1.6"	2/-

Special condensers can be made with intermediate capacities. The ganging feature may also be omitted with a consequent saving in length. Such alterations can, however, only be considered where the quantity justifies the resetting of machines to make the special parts required.

# RAYMART Precision Dials

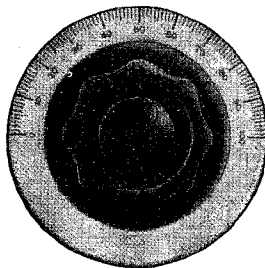

We have now increased our range of British-made direct drive precision instrument dials, as per illustration. These dials are noted for their fine appearance, accurate workmanship and non-reflecting nickel finish. The graduations are deeply engraved and black filled, being clear and easy to read. A range of fine quality knobs to match are available.

**Type TXD.** 4" dial, as illustrated, satin nickel finish, complete with indicator ... each 5/9  
 3" black bakelite skirt knob, identical with, and as used on, TXD dial ... each 1/9

**Type TXJ.** Similar and matching the above, but 2 3/4" diameter ... each 3/11  
 2 1/8" black bakelite skirt knob, as used on TXJ dial ... each 1/3

*(Owing to our heavy commitments to H.M. Services a delay in delivery on certain lines is inevitable.)*

# RAYMART LTD.

44 & 48 HOLLOWAY HEAD, BIRMINGHAM, 1

Telephone : Midland 3254

# SELECTIVITY

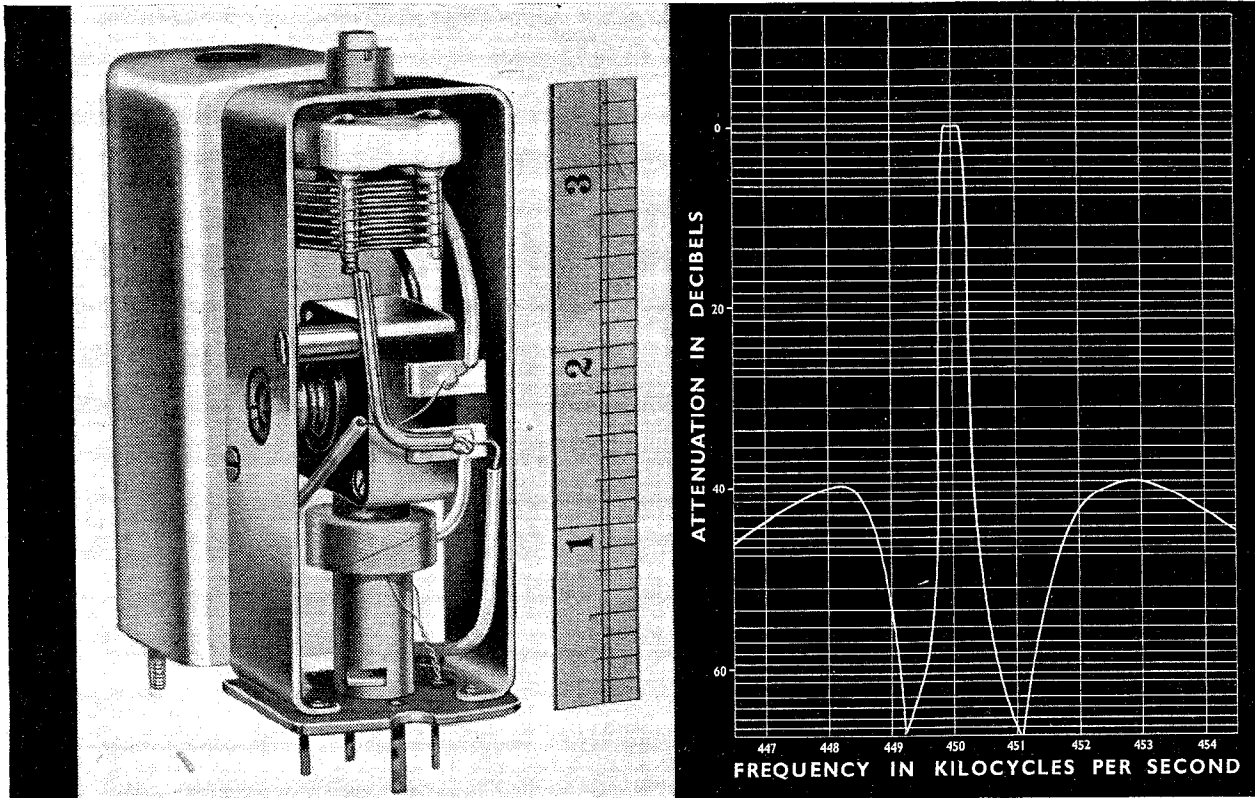

The paramount importance of high selectivity has long been recognised by radio engineers, but it is only comparatively recently that bandpass filters employing quartz crystal resonators have been made commercially available. After considerable research work our radio laboratory has evolved a new type of crystal bandpass filter employing a pair of quartz crystals, which will be found invaluable in many branches of radio tele-communication. Standard filters are available for frequencies within the range of 440-480 Kcs., having bandwidths of 300 cycles or 3 Kcs. Filters for other frequencies can be made to order. Simmonds crystal filters have an outstanding performance, including a very sharp cut-off and readily adjustable characteristics which make them very suitable for use in the Intermediate Frequency stages of super-heterodyne receivers.

## SIMMONDS DOUBLE CRYSTAL FILTER



**SIMMONDS AEROCESSORIES LTD.**

GREAT WEST ROAD, LONDON.



# Masteradio

**VIBRATOR PACKS**  
(British equivalents of American Types)

Proven for long life and reliability under war conditions (in all services, on land, sea and in the air).

Efficiency as high as 70% including rectification.

Size only 5 3/8" x 4 1/2" x 5 3/8" high and weighing only 6 lbs. approx.

60 standard types to choose from.

Outputs of up to 30 watts from 6 or 12 volts Battery. (Special Vibratorpacks up to 60 watts.)

Also 150 watts A.C. from 110 or 220 volts D.C. supply using MASTERADIO INVERTORS.

Let our Technical Staff solve your Portable Power problems.

Write for details:—

# Masteradio LTD

**VIBRANT WORKS, WATFORD, Herts.**

Grams: MASTIOLA

Phone: WATFORD 9885/9890.

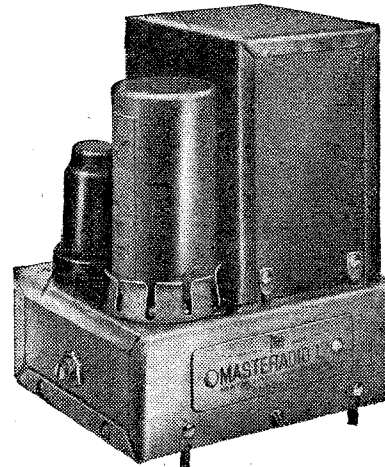

**THE PORTABLE POWER SUPPLY FOR RADIO TRANSMITTERS AND RECEIVERS.**

**PUBLIC ADDRESS SYSTEMS.**

**SCIENTIFIC APPARATUS.**

**EMERGENCY POWER SUPPLY SYSTEMS.**

Used by:

**The WAR OFFICE  
The AIR MINISTRY  
The POST OFFICE  
and POLICE FORCES.**

**A SELECTION FROM THE FULL RANGE OF STANDARD VIBRATORPACKS**

TYPE	OPERATING VOLTS	CONSUMPTION AMPS.	OUTPUT VOLTS D.C. UNSMOOTHED	OUTPUT M.A.	TYPE OF RECTIFIER
6A300	6	7	300	100	Sync. Vibrator
6B300	6	7	300	100	OZ 4 Valve
12A300	12	3.5	300	100	Sync. Vibrator
12B300	12	3.5	300	100	OZ 4 Valve
VP551	6	6/7	300-275-250-225	100	OZ 4 Valve
VP552	6	6/7	do.	100	Sync. Vibrator
VPG554	12	3/3.5	do.	100	OZ 4 Valve
VPG552	12	3/3.5	do.	100	Sync. Vibrator
VP553	6	4/5	200-175-150-125	100	OZ 4 Valve
VPG553	12	2/2.5	do.	100	OZ 4 Valve

Greenwood

# B.I. RADIO MATERIALS

We have had a long experience in the manufacture of all kinds of Cables and Wires, Aluminium Sheets and Strips, Static Condensers, Insulators and Iron Work, Telephone Cords and Copper Earthing Rods, for Radio use.



Regd. Trade Mark.

**BRITISH INSULATED CABLES LTD.**  
CABLE MAKERS AND ELECTRICAL ENGINEERS  
Head Office:  
**PRESCOT, LANCS. Tel. No. PRESCOT 6571**

TELEPHONE:

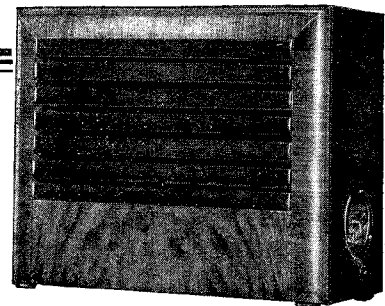

BRIG-HOUSE 50

## WHARFEDALE EXTENSION SPEAKERS "De Luxe" Model

A magnificent Cabinet—available with 10" BRONZE UNIT (6 Watts) or GOLDEN UNIT (8 Watts) as supplied to the B.B.C. Size: 16 x 12 x 8 ins.

**PRICE LIST**

CABINET MODELS	Less Transformer		V.C. extra
	With Transformer	With Transformer	
Gem ... ..	24/-	29/-	4/6
Moderne ... ..	26/-	31/-	4/6
Meritor ... ..	35/6	42/6	with V.C.
Bijou ... ..	42/6	49/6	with V.C.
Coronet ... ..	52/6	59/6	with V.C.
Bronzian ... ..	62/6	69/6	with V.C.
Louvre ... ..	65/-	73/6	with V.C.
De Luxe, Bronze Unit	75/-	82/6	with V.C.
De Luxe, Golden Unit	97/6	102/6	with V.C.

**WHARFEDALE WIRELESS WORKS**  
(SOLE PROPRIETOR D. E. BRIGGS)  
HUTCHINSON LANE BRIGHOUSE

# PREMIER RADIO

## PREMIER SMOOTHING CHOKES

Type	Current	Henrys	Res.	Prices
C 40/500	40 MA	20-34 H	500 ohms	6/-
C 60/180	60 MA	8 H	180 ohms	6/-
C 60/400	60 MA	25-34 H	400 ohms	8/8
C 60/500	60 MA	18-30 H	500 ohms	8/8
C 100/400	100 MA	20-34 H	400 ohms	10/8
C 150/185	150 MA	20-34 H	185 ohms	15/4
C 200/145	200 MA	20-34 H	145 ohms	18/-
C 250/120	250 MA	25 H	120 ohms	20/-

## PREMIER PICK-UPS

Heads (will fit any tone-arm) ... 8/9  
Premier Pick-up with Volume Control  
2,000 ohms 17/6

### ANOTHER SPECIAL OFFER

Rothermel Brush Piezo Crystal Pick-up.  
New Junior P.U. with arm, 24/6. Model  
S.8 only, 34/9.

## PREMIER 1941 HIGH FIDELITY AMPLIFIER KITS

Each Kit is complete with ready drilled chassis, selected components, specially matched valves and full diagrams and instructions.

	Kit of Parts with Valves	Completely Wired and Tested
4-watt A.C. Amplifier	£2 14 0	£3 11 6
4-watt A.C./D.C.	"	3 17 6
6-watt A.C.	6 16 6	7 13 6
8-10 watt A.C./D.C.	"	7 9 0
15-watt A.C.	7 18 9	9 8 0

Black Crackle Steel Cabinet, 17/6 extra.

## MAINS TRANSFORMERS

Wire-ends. All L.T. Windings Centre-Tapped

SP 250	250-0-250 v. 60 ma., 4 v. 1-2 a., 4 v. 2-3 a., 4 v. 2-3 a.	13/4
SP 300	300-0-300 v. 60 ma., 4 v. 2-3 a., 4 v. 2-3 a., 4 v. 2-3 a.	13/4
SP 301	300-300 v. 150 ma., 4 v. 2-3 a., 4 v. 2-3 a., 4 v. 1 a., 4 v. 1 a.	17/4
SP 350A	350-350 v. 100 ma., 5 v. 2 a. (not C.T.), 6.3 v. 2-3 a.	16/-
SP 350B	350-350 v. 100 ma., 4 v. 2-3 a., 4 v. 2-3 a., 4 v. 2-3 a.	16/-
SP 351	350-350 v. 150 ma., 4 v. 1-2 a., 4 v. 2-3 a., 4 v. 3-4 a.	17/4
SP 352	350-350 v. 150 ma., 5 v. 2 a., 6.3 v. 2 a., 6.3 v. 2 a.	18/-

Auto Transformers. Step up or down. 100-125 v. to 200, 230 or 250 v. A.C., 60 watts, 11/4; 125 watts, 15/-; 250 watts, 22/-

L.T. Transformers, all C.T.  
4 v. 2-3 a. ... 11/4 6.3 v. 2-3 a. ... 11/4  
2.5 v. 5 a. ... 11/4 7.5 v. 3 a. ... 11/4  
5 v. 2-3 a. ... 11/4 12 v. 3-4 a. ... 18/-

Push-Pull Driver Transformers, 3 : 1 ... 6/6  
Universal Output Transformers, 11 Ratios.  
Single or Push-pull ... 6/6  
Bell Transformers, 3-5-8 volts ... 5/6

## MATCHMAKER UNIVERSAL OUTPUT TRANSFORMERS

Will match any output valves to any speaker impedance.  
11 ratios from 13 : 1 to 80 : 1. 5-7 watts, 16/10.  
10-15 watts, 21/10. 20-30 watts, 36/10.  
Potentiometers, all resistances, 2/4 each; with switch, 3/3.  
Paxolin Valve Holders, chassis mounting, 4 or 5 pin, 4d. each. 7 pin, 4d. each.  
Valve Screens, for American type valves. Small size, 1/2. Medium size, 1/2.

## "LEARNING MORSE"

Premier Morse Key, Bakelite Base and Brass Movement ... 3/3  
General Purpose Morse Key ... 5/10  
Bakelite Buzzers ... 2/-  
3 Henry Chokes ... 7/6  
Complete Kit of Parts for Valve Oscillator, as described in W.W. "Learning Morse" 25/-

## PREMIER SHORT-WAVE KITS for OVERSEAS NEWS

Incorporating the Premier 3-Band S.W. Coil, 11-86 Metres without coil changing. Each Kit is complete with all components, diagrams and 2-volt valves. 3-Band S.W. 1 Valve Kit 14/9. 3-Band S.W. 2 Valve Kit, 22/6.

## DE LUXE S.W. KITS

Complete Kit, including all Valves, coils, wiring diagrams and lucid instructions for building and working. Each Kit supplied with a steel Chassis, Panel and plug-in coils to tune from 13 to 170 metres.  
1-V. S.W. Receiver or Adaptor Kit ... 20/-  
1-V. S.W. Superhet Converter Kit ... 23/-  
1-V. S.W. A.C. Superhet Converter Kit 26/3  
2-V. S.W. Receiver Kit ... 29/-

## SHORT-WAVE GEAR

Short-Wave Coils, 4- and 6-pin types, 13-26 22-47, 41-94, 78-170 metres, 2/- each, with circuit.  
Premier 3-Band S.W. Coil, 11-25, 19-43, 38-86 metres. Suitable any type circuit, 2/11.  
4-pin or 6-pin Coil Formers. Plain or Threaded, 1/2 each.  
Utility Micro Cursor Dials, Direct and 100 : 1 Ratios, 6/6.  
Bakelite Dielectric Variable Condensers. .0005 mf. Suitable Tuning or Reaction, 1/6 each.  
Short-Wave H.F. Chokes. 10-100 m., 10/d. each. High grade Ple-Wound U.S.A. type, 2/- each.  
Lissen Dual Range Screened Coils, Medium and Long Waves, 2/9 each.

## SHORT-WAVE CONDENSERS

Trolitul insulation. Certified superior to ceramic. All-brass construction. Easily ganged.  
15 m.mfd. ... 2/4 100 m.mfd. ... 3/-  
25 m.mfd. ... 2/6 160 m.mfd. ... 3/7  
40 m.mfd. ... 2/6 250 m.mfd. ... 4/-

## PREMIER MICROPHONES

Transverse Current Mike, High grade large output unit. Response 45-7,500 cycles. Low hiss level, 23/-.  
Moving Coil Mike. Permanent magnet model requiring no energising. Response 90-5,200 cycles. Output .25 volt average. Excellent reproduction of speech and music, 49/-.  
Microphone Transformers. Suitable for all mikes. Centre Tapped Primary A, 20 and 40 : 1; B, 30 and 60 : 1; C, 50 and 100 : 1. 6/6 each.  
Microphone Floor Stands, telescopic. 8 in. ring, Chrome finish, 32/6.

## PREMIER REPLACEMENT VALVES FOR ALL RECEIVERS

4 volt A.C. Types, 5-pin A.C./H.L., A.C./L., A.C./P., A.C./H.P., A.C./V.H.P., A.C./V.M. All 5/6 each.  
7-pin Types, A.C./H.P., 8/6; A.C./V.H.P., 11/3; A.C./V.H.P.B., 11/3; Heptodes, 9/-; Triode Heptode, 9/-; Triode Hexode, 13/7; D.D. Triode, 10/-; Output Pens, 12/10; P.X.4, 11/2; P.X.15, 4-watt output, 12/6; P.X.25, 16/6. Full Wave Rect., 350 v., 120 ma., 10/8; D.D. Pens, 13/6.  
A.C./D.C., .2 amp., H.F. Pens, 12/3; V.H.F. Pens, 8/6; Triode Heptodes and Triode Hexodes, 9/-; Small Type Octodes, 9/-; O.P. Pens, 12/5.  
HALF-WAVE RECTS., 9/8. FULL WAVE, 11/-.

## NEW PREMIER S.W. A.C. RECEIVER

In response to many requests we have now produced an A.C. version of the popular Premier Short Wave SG3 Kit. Circuit: Pentode H.F. Stage, Pentode Detector, Beam Power Output, and F.W. Rectifier. 200-250 v. A.C. Operation. Built-in Power Pack. Hum-free operation. For use with Phones or P.M. Speaker.

Complete Kit of Parts with drilled chassis, all components, Plug-in Coils covering 13-170 metres, 4 valves and full instructions and circuits

£4-10-0

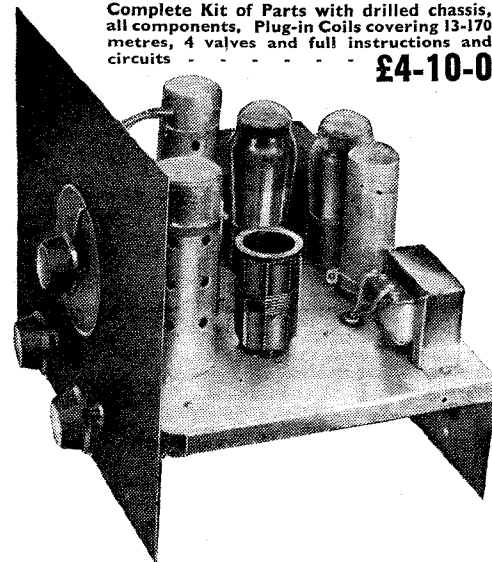

BATTERY VERSION KIT also available £3 8 0  
EXTRA COILS 9—15, 200—2000 m. also supplied

"The Wireless World" said they were  
★ "Very much impressed" ★  
See full Test Report pp. 492-3 December issue  
Send for full details

## PREMIER BATTERY CHARGERS for A.C. MAINS

Westinghouse Rectification complete and ready for use  
To Charge : 6 volts at 1 amp. 26/-  
2 volts at 1/2 amp. 13/4 12 volts at 1 amp. 28/-  
6 volts at 1/2 amp. 22/- 6 volts at 2 amps. 43/6  
24 volts at 1 amp. 52/6 36 volts at 1 amp. 73/6

## MOVING COIL SPEAKERS

All complete with transformer. Rola 6 1/2 in., 15/-;  
Sin. P.M.s, 17/6; 10 in. P.M.s, 22/6.  
ENERGISED MODELS  
Plessey 8in., 175 ohm field, 7/6; 10in. B.T.H. 1,600 ohm field, less transformer, 11/6. Magnavox 154, 2,000 ohms Universal transformer, 15/-

ALL ORDERS UNDER 5/-, 6d. postage extra  
All enquiries must be accompanied by 21d. stamp

ALL POST ORDERS to:

JUBILEE WORKS, 167, LOWER CLAPTON ROAD, LONDON, E.5 (Amherst 4723).

# PREMIER RADIO CO.

CALLERS to:

Jubilee Works, or 169, Fleet Street, E.C.4 (Central 2833), or 50, High Street, Clapham, S.W.4 (Macaulay 2381).

*INCREASED PRODUCTION AT LOWER COST*

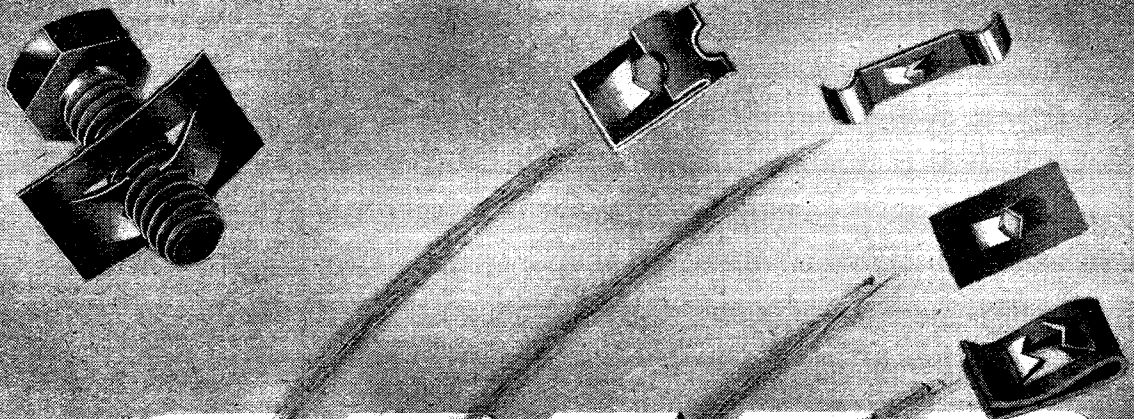

# SPEED UP

with *Simmonds Speed Nuts*

The "U" shaped Speed Nut here is for use in blind assembly. It has an extruded hole in its lower leg so that when a stamped part is snipped into bolt hole to give a perfect and constant register.

These Speed Nuts, which in each case eliminate a stamping, a nut and a lock washer, solve the problem of bolting wires, conduits and coils securely in place.

Applied to integrally moulded plain studs, eliminates necessity of threaded inserts, ordinary nuts and spring washers.

This revolutionary fastening method is providing the solution to assembly problems in all branches of engineering, enabling manufacturers to accelerate assembly, halve handling time and effect considerable savings in costs and material.

There is a wide range of standard Speed Nuts. Our Development Department will be pleased, however, to design special types to meet your particular needs if necessary. Get into touch with us and prove for yourself the efficiency and economy of the Speed Nut.



**SIMMONDS AEROCESSORIES LTD**  
GREAT WEST ROAD, LONDON.



Longleys



# The Wireless World

COVERING EVERY WIRELESS INTEREST

31st Year of Publication

Proprietors : ILIFFE & SONS LTD.

No. 1066

Vol. XLVII. No. 4

Editor :

HUGH S. POCOCK.

Editorial,

Advertising and Publishing Offices :

DORSET HOUSE, STAMFORD STREET,  
LONDON, S.E.1.

Telephone : Waterloo 3333 (35 lines).  
Telegrams : "Ethaworld, Sedist, London."

COVENTRY : 8-10, Corporation Street.

Telegrams : "Autocar, Coventry." Telephone : 2510 Coventry.

BIRMINGHAM :

Guildhall Buildings, Navigation Street, 2.

Telegrams : "Autopress, Birmingham." Telephone : 2971 Midland (5 lines).

MANCHESTER : 260, Deansgate, 3.

Telegrams : "Iliffe, Manchester." Telephone : Blackfriars 4412 (4 lines).

GLASGOW : 26B, Renfield Street, C.2.

Telegrams : "Iliffe, Glasgow." Telephone : Central 4857.

PUBLISHED MONTHLY.

Price : One Shilling

(Publication date 20th of preceding month.)

Subscription Rates :

Home and Abroad, 14/- per annum.

*As many of the circuits and apparatus described in these pages are covered by patents, readers are advised, before making use of them, to satisfy themselves that they would not be infringing patents.*

## APRIL, 1941

### C o n t e n t s

EDITORIAL .. .. .	97
PHOTOGRAPHING TRANSIENTS. By T. H. Turney, Ph.D.	98
POST-WAR AMATEUR TRANSMISSION. By "Jaybee" ..	101
COMBINING HIGH- AND LOW-FREQUENCY LOUD-SPEAKERS .. .. .	103
CONSTANT BAND-WIDTH TUNING .. .. .	105
LETTERS TO THE EDITOR .. .. .	106
INDUCTANCE CALCULATIONS. By S. W. Amos, B.Sc. (Hons.)	108
THE WORLD OF WIRELESS .. .. .	110
NEWS IN ENGLISH FROM ABROAD .. .. .	112
"MYSTERY" RECORD PLAYERS .. .. .	113
OVERHAULING OLD RECEIVERS. By "Service" .. .. .	114
PHILIPS MODEL 206A : Test Report .. .. .	116
SHORT-WAVE RECEIVING CONDITIONS .. .. .	117
RANDOM RADIATIONS. By "Diallist" .. .. .	118
UNBIASED. By Free Grid .. .. .	120
RECENT INVENTIONS .. .. .	121

## WORLD CONTACT WITH A TROPHY

IN THESE HISTORIC TIMES WORLD LISTENING PROVIDES A NEVER ENDING SOURCE OF INTEREST AND ENTERTAINMENT.

THE  
TROPHY IS  
SPECIALLY DESIGNED  
FOR ALL-WORLD  
RECEPTION



TROPHY 6 Valve incorporating all latest improvements, 10 to 545 metres. Built-in Speaker, A.C.  
£11.11.0 or £4.14.8 deposit and 34/6 monthly. Purchase Tax £2.9.8.



TROPHY 8 Valve A.C. A super communication receiver with amazing range. 7 to 550 metres.  
£14.19.6 or £6.4.5 deposit and 44/- monthly. Purchase Tax, £3.4.5.

PETO SCOTT CO. LTD.

Showrooms at 77, CITY ROAD, E.C.1.

SEND FOR FULL SPECIFICATION

# NO substitutes ?

In this series of advertisements we have talked about a number of substitutes and circuit changes, which have been adopted since war began to preserve some measure of continuity in the manufacture of domestic Radio sets . . . an activity which, side by side with our "direct" war work, we feel to be of considerable importance in the National interest.

But it has been obvious all along that there were some things for which no substitutes could ever be found, and that when the Services' requirements became still larger (as is already happening), the output of sets to keep the broadcast audience

intact would inevitably decline below even the very reduced levels of the last eighteen months.

Murphy sets were always designed to be reliable over a long period of use, but as new sets become more scarce it seems likely that existing ones may have to be used for a longer time and perhaps under more severe conditions than was ever intended. No manufacturer has designed sets to stand up to being blown off the table by a near-by bomb—but lots of Murphy sets are doing just that nowadays!

The only real alternative to new sets is a complete and widespread

repair organisation, which in itself is no easy thing to maintain under present conditions, when skilled personnel, as well as materials, are scarce. Added to this, there must be many sets for which repair facilities are no longer available, or where the cost of repairs would be prohibitive.

So far as our own sets are concerned, we have reasonable reserves of "spares," and with the help of Murphy Dealers intend to keep our repair service going to the best of our ability, so that if it should be necessary, Murphy sets at any rate may continue to give good service throughout the war.

*All Murphy Sets exclusive of Valves  
and Batteries guaranteed for one year*

# MURPHY

MURPHY RADIO LIMITED  
Welwyn Garden City, Hertfordshire

# The Wireless World

COVERING EVERY  
WIRELESS INTEREST

ESTABLISHED  
1911

Vol. XLVII. No. 1066

APRIL, 1941

Price One Shilling 3

## “A Sole Exclusive Heaven”

### *The Future of Amateur Radio*

**A** RECORD of the virtues and achievements of the Radio Society of Great Britain appears in the February issue of the *T and R Bulletin*, the official journal of the Society. This catalogue commences with a reference to the article by “Navigator” in *The Wireless World* of the same month under the title of “The Future of Amateur Radio,” and ends with the statement, “the Society, proud of its past record, regrets that so valued and so long established a contemporary should have permitted a contributor to ignore so completely, or display such ignorance concerning the work being done by the Society. . . .” Now, our contributor’s article was discussing the amateur position as a whole, and not the activities of the R.S.G.B., and we fear that the writer in the *T and R Bulletin* is so steeped in the work of the R.S.G.B. that he has (inadvertently, we hope) taken up the view that unless you are a member of that body you are not an amateur wireless transmitter.

A dangerous view this, and one which, coupled with the author’s remark that from 1921 to 1939 the Society was privileged to recommend members for high-power permits to the Post Office, suggests that the attempt might be made to make membership of the R.S.G.B. a necessary qualification for a transmitting licence from the Post Office.

Such a state of affairs would be a sad reflection upon Post Office administration, and would, we believe, be quite unconstitutional.

If the general question of amateur wireless transmission and its future status is not to be freely discussed without full acknowledgment to the R.S.G.B. for its services to amateur radio, then surely in turn we should be entitled to expect that no reference to the R.S.G.B. should be made without acknowledgment to that “contemporary” (ourselves) which for many years published the Society’s papers and in every way nursed and assisted the Society, not only in its early youth but on every occasion since when we have found it possible to be of help by word or deed.

No, R.S.G.B., to claim a “sole exclusive heaven”

for yourselves will not further the cause of amateur radio, but might well antagonise not only those who are your friends and helpers to-day, but those thousands who have come into radio through the war, and must be left to decide for themselves at some later date whether they wish to pursue their radio interests as members of a society or as individuals.

Amateur wireless transmission, more than most other activities, requires organisation; official control by the G.P.O. is not in itself enough. A strong and efficient organisation of the amateurs themselves, enjoying the fullest confidence of all its members, is essential if the movement is to progress after the war. If it grows to the extent that we expect, something not far short of chaos would result if the R.S.G.B. were to lose that confidence. We can only hope that the strange attitude reflected in the *T and R Bulletin* is due to some unfortunate misconception, and is not really typical of the Society’s official outlook.

**ELSEWHERE** in this issue we publish another article giving more views on post-war amateur transmission. One point made by the author should, we think, be stressed. In considering what is to most of us the more interesting question of the conditions under which transmission should be permitted, we are apt to lose sight of the fact that it is important, first, to establish the broad principle that a licence for transmission should be obtainable by everyone who is fit to hold one. The case for such a state of affairs is a good one, if only because space in the ether is but a small reward for the services rendered by amateurs during the present war. But gratitude is short-lived, and we must be armed with more reasons than that if officialdom is to be convinced on the matter.

Another point, certainly more controversial, is raised by our contributor’s suggestion that the morse test serves no useful purpose, and that it should be replaced by a technical test. At first sight, complete ignorance of morse in a transmitting amateur seems all wrong, but perhaps such a view is mere conservatism.

# Photographing Transients

*Observation Simplified by Automatic Repetition*

By T. H. TURNEY, Ph.D.

IT has been shown by Heaviside that the transient current in a circuit caused by switching on a DC voltage is of great value in deducing the properties of that circuit. The difficulty of observing or photographing a transient on the oscillograph is due to the fact that, as its name shows, it is quickly over. The author's method is to produce the same transient over and over again

is amplified, and fed to the cathode ray oscillograph. This then indicates the current entering the circuit on test.

The square-wave generator used is based on a circuit due to W. K. Clothier, which was described in the *Journal of Scientific Instruments* for September, 1939, under the title "A Hard Valve Electronic Relay Switch." It is shown in Fig. 2, and

A square-wave generator is used to give repeated applications of DC to the circuit under test, and the resulting transients are observed or photographed on a cathode ray tube with synchronised time base. The method is of special value in studying the properties of filter circuits.

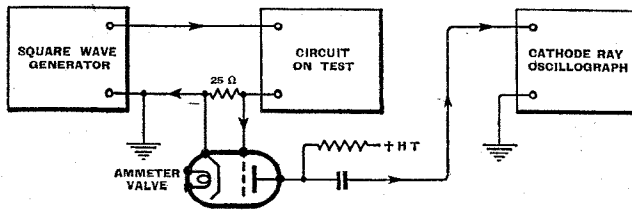

Fig. 1. Schematic layout of apparatus for taking oscillograms of transients.

by applying a continuous train of square-topped waves to the circuit under test, and to observe the repeating waveform on an oscillograph with a synchronised time base.

A schematic circuit is shown in Fig. 1. The square-wave generator returns current to the circuit on test, returning through the 25-ohm resistance which acts like an ammeter shunt. The voltage across this shunt

consists of three parts, together with power amplifier and ammeter portions designed by the present author.

The multivibrator consists of a double triode valve with each plate resistance-capacity coupled back to the other grid. Such a circuit is unstable, because a slight negative voltage on, say, the upper grid, puts a positive pressure on the lower grid through the coupling condenser, as

shown by the arrows, and this intensifies the first effect. As there is no inductance in the circuit the two grids go to opposite polarities at once, and then, because the condensers slowly stop the current flow, the grids come back to normal, only to go off in the other direction. The output waveform is shown in Fig. 3.

This current is fed through filter condensers to a trigger circuit which is very like the first circuit, but without the coupling condensers: i.e., pure resistance coupling. This circuit has two stable positions, a "small current" and "large current" position, for each valve. It

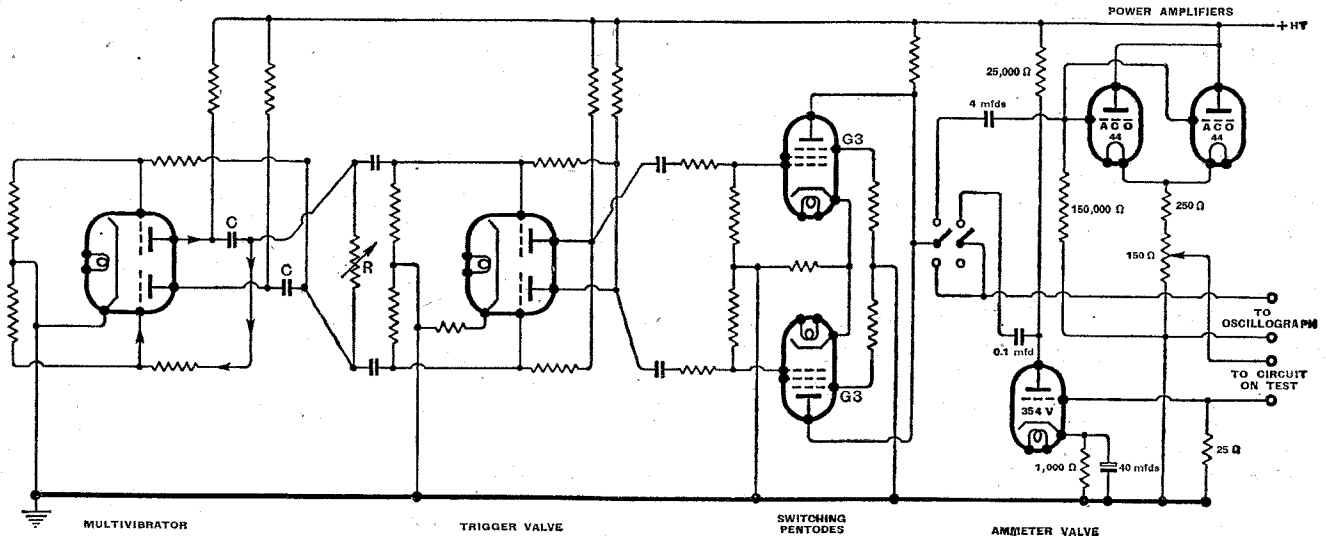

Fig. 2. Circuit diagram of square-wave generator and auxiliary output stage.

### Photographing Transients—

is "kicked" from one to the other by the pulses from the first circuit and so turns out square waves. The condensers which follow the vibrator circuit allow a sharp kick to act on the trigger circuit.

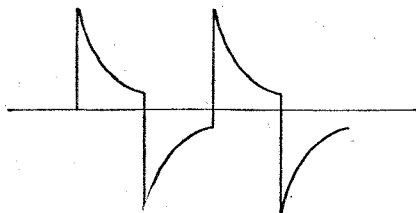

Fig. 3. Waveform of voltage from multivibrator stage.

The original circuit was designed to act as a switching device for external waves, and not for turning out a square wave. The square wave in the original circuit is used to free and suppress in turn two pentodes, and by feeding two separate waves to the two grids (G<sub>3</sub>) of the pentodes, the two waves can be seen together on the one oscillograph.

The writer feeds the square wave to two power triodes in parallel as a cathode follower. No input is now



Fig. 4. Oscillogram of square wave applied to circuit under test. The vertical rise of current is too rapid to show on the plate.

needed on the spare G<sub>3</sub> grids of the pentodes. A change-over switch is included so that the original circuit may be used or its waveform checked at any time. The object of using a cathode follower is to reduce the impedance looking back into the source of the impulses, and the third valve is what one may call an "ammeter valve," for giving a deflection on the oscillograph which is proportional to the current entering the circuit under test. The grid of this valve is connected to a 25-ohm resistance in the return lead, and so measures the drop across it. This

25 ohms is low enough to avoid interfering with circuits of the 500-ohm variety, such as filter circuits, and may be made lower by suitable shunts.

The two power valves have a 150-ohm potentiometer in their common lead, and as it is a "cathode follower" arrangement, the impedance looking back to the potentiometer is at most not 150 ohms but  $\frac{I}{I + \mu}$  of 150 ohms, or about 20 ohms when the volume dial is turned to the "full" position. The square wave is shown in Fig. 4.

The frequency range is from about 13 c/s to 13 kc/s. To obtain a frequency calibration, a low-pass filter and also a frequency meter de-

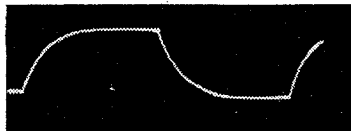

Fig. 5. Oscillogram of current in simple circuit with inductance and resistance.

veloped by the writer were put on the square-wave generator. By this means the generator was calibrated in cycles per second for various positions of the frequency control. The frequency is determined by the values of R and C in the first circuit.

### Time Base

The purpose of frequency calibration is to enable the scale of time of the Heaviside current functions to be read off; for example, 200 c/s means  $2\frac{1}{2}$  milliseconds between one pulse and the next reversal.

In taking photographs the pulse frequency should be noted each time. By putting an ordinary oscillograph on the synchronising terminals of the Clothier circuit and also on the oscillograph synchronising circuit, the picture may be held very steadily indeed, but the oscillograph and the square-wave generator must be set closely to the same frequency in order to get this steadiness.

This circuit now enables transients to be photographed easily without special and difficult timing devices between the camera and the oscillograph. It reduces the photography of transients to the taking of an ordi-

nary photograph. Three seconds' exposure with 1,500 H & D plates is enough at f/6.3.

It is also possible by putting a sine wave on to the spare (G<sub>3</sub>) pentode grids to show the effect of

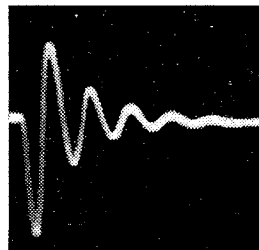

Fig. 6. Transient resulting from application of DC to a circuit with inductance, capacity and resistance.

suddenly switching a sine wave on to a circuit. It is the square wave, however, that is the most useful. In operation, the frequency of the vibrator must be lowered to make the time of one pulse long enough for the transient to die away. One transient should not run into the next.

Why does Heaviside use a DC voltage to switch on? The answer is twofold. First, because it is simple, and, secondly, because the current flowing in response to one volt in any circuit enables the performance of that circuit to be calculated for any applied voltage, by an integral. This may be done in two pairs of ways, four in all, and the possibility was mentioned by Heaviside in his books.

In short, test a circuit for impedance, say, with a sine wave at one frequency, and you know its impedance at that frequency, but you know nothing more about the circuit. Test the circuit by applying one volt DC, oscillograph the current and you can tell its response to any applied voltage after that, including its impedance at any frequency you may like to mention (that is if you can do any one of the four integrals involved).

The putting on of a DC voltage is like applying square waves at a very slow speed. Hence the importance of square waves. Suppose the square-wave oscillator is connected to an inductance coil with resistance, then if the frequency is slowed down until the transient term  $e^{-\frac{R}{L}t}$  has

## Photographing Transients—

time to die away during the one cycle, the curve is traced by the oscillograph over and over again at every repetition of the square wave, giving a steady image of the ex-

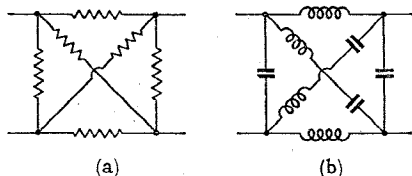

Fig. 7. "Gate" filters of the type investigated by the author.

ponential law which can be looked at or photographed at leisure (Fig. 5).

The case of the circuit consisting of a coil, condenser and resistance in series was studied by Kelvin, and, as is well known, has an oscillatory and a non-oscillatory condition depending on the amount of resistance in the circuit. The oscillatory current is shown in Fig. 6. It is most instructive to set the circuit up and vary the values of L, C and R one at a time. An interesting fact emerges. In the mathematics, as the value of the resistance is increased and the current curve ceases to go below the time axis, there is an abrupt change in the mathematical terms from unreal roots and a sine function, to real roots and a sinh function. In the physics, however, no such abrupt change takes place. As resistance is added, the curve is continuously deformed from one shape to the other.

The author built up the square-wave circuit to study transients in

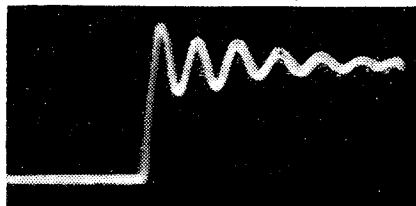

Fig. 8. Current entering simple low-pass ladder filter.

filters, and in particular to investigate a class of filters of the type indicated in Fig. 7 (a). In these "gate" filters as in, say, ladder filters, the coils and condensers can be arranged to give different types of characteristic. For instance, the circuit of Fig. 7 (b), with a proper

relation between coils and condensers, makes a "low pass" filter which has superior characteristics as regards the even value of its impedance and the sharpness of its cut-off when compared with a ladder filter.

Latitude is available, too, for designing either for the best impedance or else for the best attenuation. The author has band- and high-pass filters in the same series. The object was to compare the transient for the gate low-pass filter with that for the ladder low-pass filter.

When Heaviside's DC is switched on to an infinite half-series-ended low-pass ladder filter the current is known from a Bessel function. In practice, one cannot build a filter infinitely long, but one can try a few sections with a resistance at the far end. The result is given in

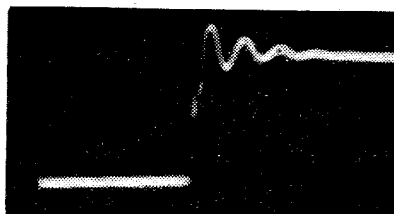

Fig. 9. Initial transient of special low-pass gate filter designed to reduce amplitude of oscillation.

Fig. 8. A filter of more complex mathematical design which should give much reduced amplitude of oscillation was made up and tested by the writer. The validity of the reasoning, was confirmed by the oscillogram shown in Fig. 9. The Bessel functions when taken from tables and plotted on graph paper give curves exactly like the corresponding oscillograms.

## Increasing Morse Speed

WE hear a lot nowadays about learning the morse code, but most of the advice that is available is intended for beginners. There comes a time, however, in the experience of both amateur and professional operators when they reach a certain speed and seem unable to advance much beyond it, no matter how assidu-

ously they practise. It is suggested by a writer in the February *QST* that this is usually the result of having learned the code as dots and dashes instead of as rhythmic sounds. The result is that the listener, hearing a letter sent in morse, has to translate the sound he hears into dots and dashes and then translate these into letters of the alphabet. In the case of transmitting, the opposite process has to be gone through. Incidentally, the rhythmic method is strongly advocated in *The Wireless World* booklet, "Learning Morse," of which the 5th edition has just appeared.

At slow and medium speeds this mental juggling can quite easily be carried out. At higher speeds, however, there is simply no time for it, and so progress seems to be halted at the threshold of rapid working. To get out of this rut a course of assiduous listening to good commercial sending is advised, it being assumed that sufficient progress has been made to read at the medium speed at which many such transmissions are sent. If such progress has not been made, of course, it is more or less necessary to return to the beginner stage.

Even those who have learned morse properly as rhythmic sounds sometimes have difficulty in attaining high speeds. This is because they fail to realise that the really high-speed morse operator does not read his rhythmic sounds letter by letter. He learns to recognise the rhythmic sounds corresponding to all the more common words of the language, and no longer divides the sound up into letters of the alphabet. It is not hard to learn to do this. The man who can read fifteen to twenty words per minute will be able to listen to thirty-five to forty words per minute and pick out the more common words like "the" and "and" straight away. By assiduous listening he will soon enlarge his rhythmic vocabulary.

With regard to learning to send rapidly, it may be said at once that anybody can send rapidly. The difficulty is to send rapidly and clearly. Most people fall down in the matter of correct spacing, and this is what makes many operators' sending practically unreadable even to the expert. A remedy suggested by the *QST* writer is to find a commercial "tape" station which is sending double, that is to say which is repeating each word twice, using non-manual sending. Listen carefully to the initial sending of the word and then, by means of a key and buzzer, endeavour to keep in exact synchrony with the word when it is sent a second time.

# Post-War Amateur Transmission

## *More Thoughts for the Future*

**T**HE article, "The Future of Amateur Radio," in the February issue raised a number of interesting points with which many will agree. However, a number of the points raised must give rise to some controversy, and it is with the object of stimulating further interest in the subject that the writer submits the following observations.

It can be assumed that, after the war, commercial interests, both broadcasting and communication, will do their utmost to acquire all available wavelengths, and unless the amateurs can get quickly off the mark with a prearranged plan, their future survival will be in doubt. It is too much to hope that their previous contributions to the art, or even their wartime contributions, will be given much consideration by those whose primary object is to secure more channels. It should also not be forgotten that the authority which makes the final decisions on amateur activities is itself a user of radio channels for both radio-telegraphy and telephony.

It appears to the writer that the only real way of influencing the authorities is to put up a first-class general reason as to why amateurs should be allowed space in the frequency spectrum. This is not to say that the number of arguments should be restricted, but rather that there should be one fundamental prin-

This photograph, showing only one of three morse classes conducted in the same building gives a graphic impression of the scale on which wireless men are entering the R.A.F. As many of them will retain an interest in wireless after demobilisation, it also gives an idea of the extent to which the ranks of would-be amateur transmitters will be swelled after the war.

By "JAYBEE"

ciple underlying all the arguments and that this principle should be of a type which can be made clear to the political mind. Assuming that such a principle can be set down and accepted it is possible to turn to some of the detailed items discussed in the original article.

### **Eliminating the Undesirables**

It is an undoubted fact that some of the amateur telephony heard in recent years made one feel ashamed of one's associates, and whilst it was notoriously bad on 7 Mc/s, it was also becoming prevalent on 14 Mc/s and achieving world-wide publicity.

It will be difficult to frame regulations which will entirely eliminate that sort of thing, but it should be possible to reduce it considerably, as such behaviour is symptomatic of a weakness of mind which is unlikely to carry the victim very far in the assimilation of technical knowledge. For that reason the writer inclines

towards an oral technical examination, instead of a morse speed test, as the criterion for granting a permit.

While admitting the advantage of some degree of telegraph ability, it is a little difficult to see just what value this can have from the standpoint of the authorities. In twenty-one years' experience of amateur transmission, ranging from 1,000 metres to 5 metres, the writer never encountered a case in which wireless telegraphy was used by an official station in order to give instructions to an amateur.

Similarly, the grading of licences using morse speed as a criterion would appear to achieve little, apart from an arbitrary means of reducing the number of amateurs permitted to use the extended facilities, and it certainly would not discriminate between those who are fit and those who are not fit to use higher powers or special frequency bands. In that respect an age limit restriction would be just as effective in reducing the number and far more likely to produce the desired results.



## Post-War Amateur Transmission—

Turning to the question of the non-radiating artificial aerial licence the writer finds it difficult to believe that this serves any useful purpose and feels that the G.P.O. would be much better occupied in attending to the activities of radiating stations than in spending time over the formalities associated with artificial aerials. It is, in fact, very doubtful whether the peacetime legal position permitted the G.P.O. to apply any restrictions whatsoever on non-radiating experiments.

It is suggested that departmental economy together with the doubtful legal aspect provide a much stronger argument for eliminating the artificial aerial licence than does that of "piracy," as there were probably just as many pirates not holding such a permit as there were with the permit.

## Allocation of Channels

With regard to wavebands, the amateur demands might well be based upon the characteristic behaviour of the radiations in the various regions of the spectrum, the object being to acquire that variety of channels which gives the greatest possible differences in transmission behaviour. In that connection the pre-war allocation was quite good, although it was largely fortuitous owing to the habit of giving to amateurs those parts of the spectrum which were originally believed to have little commercial value.

The wavebands of 1.7, 3.5, 7, 14, 28 and 56 megacycles give ample variety, and if 112 Mc/s can be added, so much the better. If it is thought desirable to put some graduation on the use of wavelengths it is believed that for the first year a licensee should be restricted to 1.7, 7, and possibly 28 Mc/s, and later be given the entire range. This would do away with the farce of having to rake up technical reasons for wishing to use certain reserved bands.

With regard to discrimination between telephony and telegraphy, the writer believes this to be unnecessary and undesirable. It seems to be generally recognised that a badly adjusted telephone transmitter causes more interference than a badly adjusted telegraph transmit-

ter. It is, however, quite probable that in actual practice the telephone transmitter has produced the greater number of complaints because the sufferer has been able to interpret the telephony, thus enabling the station to be identified, whilst an interfering telegraph has not been recognised and remained untraced.

With the resumption of television services, the problem of the third harmonics from the 14-Mc/s amateur band falling within the television bands may assume considerable importance. It had already achieved some prominence prior to the war. The telegraph transmitter may be just as prolific a source of such trouble as the telephone transmitter.

On the subject of high power it is the writer's view that far too much attention has been focused on high power *per se* when it should really have been directed towards the lack of technical ability of some of its users. It is probable that the only external danger which high power has over low power, assuming both to be in the hands of a reasonably competent operator, lies in the production of harmonics, and even these can be dealt with satisfactorily if the experimenter possesses real technical knowledge.

## Code of Manners

The question of fundamental interference is, of course, a matter depending upon the degree of courtesy which obtains in the amateur ranks, and it should hardly be necessary to call in the G.P.O. for the purpose of setting up regulations in order to enforce good manners. Apart from the harmonic problem, a 10-watt station can, on occasions, be just as troublesome as a 50-watt station, much depending upon the concentration of amateurs in the district, whilst the degrees of trouble caused by 50-watt and 100-watt stations are not greatly different. The writer therefore proposes that the high-power question be discussed around 100 watts instead of 50 watts, that the basis for granting a permit should be one of technical ability, and it should be made a rule that all high-power stations must be capable of immediate operation at reduced powers, say, down to  $\frac{1}{3}$ th of the licensed maximum. This should encourage

the use of low power for short-range operation.

Traffic handling can be ruled out as the G.P.O. can hardly be expected to relax any part of their monopoly, while attempts to segregate amateurs into experimenters and DX operators should be discouraged as they only confuse the main issue and, in any case, there is no hard-and-fast line.

The suggestion to appoint a committee is a good one, provided the committee is small and its members have plenty of vitality, but one of the troubles will be to secure the right type of member. It would be unwise to place too much reliance on the enthusiastic radio amateur, as the petitioner is far from being the person best suited to present his own case. A skilled negotiator and, if possible, a Member of Parliament who could take the matter into the political arena, should be among those representing amateur interests.

A body which might be persuaded to take an interest in the subject is the Radio Manufacturers' Association, as it represents an influential number of manufacturers who are interested in extending the use of radio equipment without being influenced by communication interests.

Finally, it must be emphasised that, so far as the present situation will allow, everything possible should be done to enable a quick start to be made after the war.

## Club News

### Ashton-under-Lyne and Dist. A.R.S

**Headquarters:** Beaconsfield Conservative Club, Stalybridge Road, Ashton-under-Lyne, Lancs.

**Meetings:** 8 p.m., Wednesday and Friday.

**Hon. Sec.:** Mr. K. Gooding, 7, Broadbent Avenue, Ashton-under-Lyne.

The conversion of the club's receiver from AC to DC was recently completed, and was calibrated with the aid of a signal generator and associated gear lent by Mr. W. Taylor.

Several members of the local squadron of the A.T.C. have joined the club to obtain additional morse practice and instruction on the principles of radio.

On April 2nd at 8 p.m. a lantern lecture and demonstration will be given by Mr. Robinson, of Cossors, and Mr. A. J. Aiers, the subject being "Quartz Crystals." Mr. Aiers will deal with their growth and formation, and Mr. Robinson with the cutting, grinding, and applications of them.



# Combining High- and Low-frequency Loud Speakers

## Simple Dividing Networks for Use After the Amplifier

IT is now generally acknowledged that a wide frequency response, if not the only factor involved, is nevertheless an indispensable requisite for really high quality of reproduction. Now the simple cone diaphragm, which for many reasons is the most practicable form of radiating surface for use in loud speakers, shows a marked reluctance to deal efficiently with more than one limited section of the acoustic spectrum at a time. Efforts to improve the performance at one end of the scale are usually accompanied by a corresponding deterioration at the other.

## Loud Speakers

Very little data has hitherto been published on loud speaker dividing networks, and the information contained in this article should make a useful entry in the amateur designer's notebook

The solution is to combine the output of two or more cones of different sizes and characteristics, and this has been accomplished successfully in single-magnet units such as the Voigt and the Goodmans Auditorium, which make use of composite diaphragms. Where considerable acoustic powers have to be handled, as in cinema installations, a number of loud speakers must be used. These are generally grouped in two banks, one dealing with the extreme bass and the other looking after the more directional high frequencies. The arrangement usually adopted in these days is to use a battery of large cone-diaphragm speakers mounted in a common baffle for general distribution of the bass and multi-cellular horns for directing the high frequencies evenly over the auditorium.

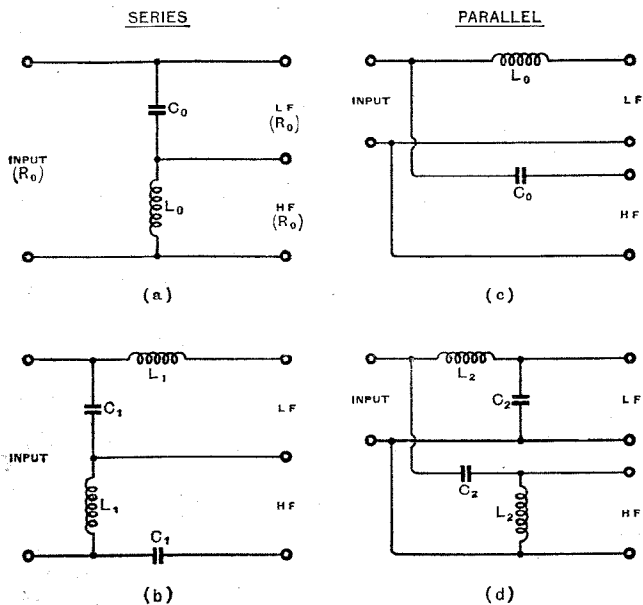
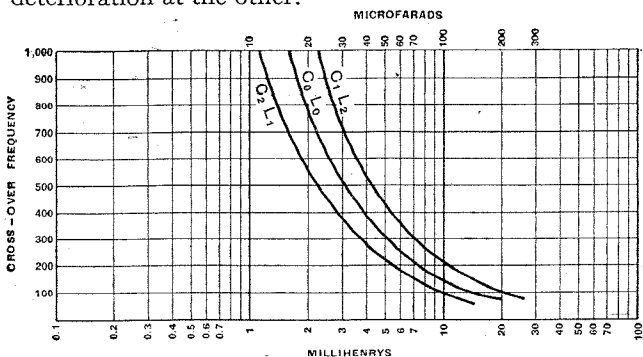

Fig. 1. Constant resistance dividing networks with design curves based on a characteristic resistance of  $R_0 = 10$  ohms. For other values, multiply inductances by  $R_0/10$  and divide capacities by  $R_0/10$ .

### Cross-over Frequency

When using separate reproducing systems for high and low frequencies, it is most important that the change-over should be effected smoothly without introducing gaps or undue reinforcement in the middle register. Low frequencies must be kept out of the HF units to prevent damage to the diaphragm assembly, and high frequencies reaching the LF units may produce distortion by entering a part of the frequency range where the diaphragm "breaks up" and produces multiple resonances.

The electrical filters used for segregating the high and low frequencies may be introduced in early stages of the amplifier with separated output stages for each channel, but it is more economical to put the filters between the output transformer and the loud speakers, when a standard straight amplifier may be used. In designing such filters a suitable rate of attenuation beyond the cut-off frequency must be achieved with the minimum number of circuit elements, otherwise serious power losses may result in the "pass" range from the residual resistance of the various components.

## Combining High and Low-Frequency Loud Speakers

In a recent article\* the practical design of suitable filters has been reduced to its simplest terms, and the data given should prove of interest to quality enthusiasts who may wish to experiment with different loud-speaker combinations.

The simplest dividing networks are those of the so-called constant resistance type shown in Fig. 1. Component values are chosen so that as the impedance of one branch rises with frequency the other falls. If the load resistance of the speakers connected to each branch is  $R_0$  a constant impedance of  $R_0$  will be presented at the input terminals. The networks may be of the series or parallel type, and design data for a working resistance  $R_0$  of 10 ohms are given in the curves in Fig. 1.

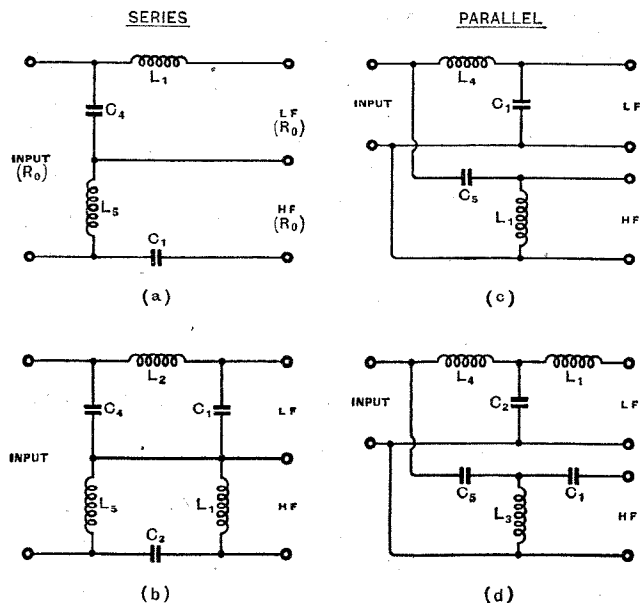
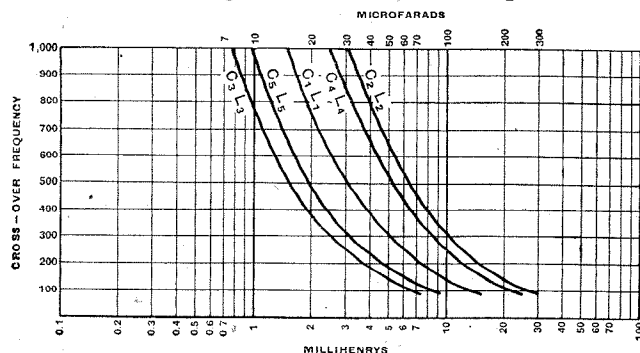

Fig. 2. Series and parallel dividing networks with design data based on filter practice with  $R_0=10$  ohms. The half-section filters give an attenuation of 12 db. per octave and the full-section 18 db. per octave beyond the cut-off frequency. Corrections for values of  $R_0$  other than 10 ohms are the same as for the circuits of Fig. 1.

The advantage of the constant resistance type of network is that the same values of components may be used in each branch. The circuit of Fig. 1 (d) is com-

\* "Loudspeaker Dividing Networks," by John K. Hilliard, *Electronics*, January, 1941.

monly used, but in some cases, for instance, where the low-frequency loud speakers have a relatively high input impedance below resonance, the impedance reflected at the input terminals may deviate from the normal value and more uniform overall attenuation on either side of the change-over frequency is obtained by using a series type.

Dividing networks designed in accordance with filter principles are more flexible and in many ways preferable to the constant resistance type. Some examples of both series and parallel types made up of half- and full-filter sections are shown in Fig. 2. The similarity between Fig. 1 (b) and (d) and Fig. 2 (a) and (c) will be noted, but in the latter case the component values in the HF and LF sections are different.

In the series network, " $\pi$ "-type filters are employed, while for parallel connection " $T$ " sections are used. The full sections give attenuation of 18 db. per octave and the half-sections 12 db. per octave beyond the cross-over frequency. The design is of the m-derived type, the customary value of  $m=0.6$  being used as the basis of the curves of Fig. 2.

It will be noted that the capacity values called for are high. These will be reduced to manageable figures by choosing loud speakers with high speech coil impedances and cross-over frequencies as high as the characteristics of the LF loud speaker will permit.

## Rate of Attenuation

With regard to the degree of attenuation on either side of the cross-over frequency, there seems to be general agreement that 12 db. per octave is the optimum rate. This is given by the circuits of Fig. 1 (b) and (d) or Fig. 2 (a) and (c). The simplest circuits Fig. 1 (a) and (c) allow only 6 db. per octave, which is not quite enough, while the circuits of Fig. 3 (b) and (d), which give 18 db. per octave, are inclined to give unwanted attenuation in the pass range, and should be used only in special cases.

Although theoretically the output transformer from the amplifier should be designed to match the characteristic impedance  $R_0$  of the network, in practice it is better to make it  $0.3 R_0$  to  $0.4 R_0$ . Thus, for HF and LF units with 10 ohm speech coils, the filters would be worked out for  $R_0=10$  ohms, but the transformer ratio would be chosen for a 4 ohm load. The change in the performance of the network resulting from this asymmetrical loading is negligible, but the advantages of the damping action on the loud speakers is considerable, and interaction is reduced since very little counter EMF is developed across the input terminals. The original paper does not discuss the effect of mismatching on the performance of the power valves, but some allowance must presumably be made for the resulting restriction in the available undistorted output. Generally there will be an ample factor of safety, but if the margin of reserve power is small it would be as well to check the undistorted power available by drawing in the new average load line or ellipse on the valve characteristics.

# Constant Band-width Tuning

## Use of "Staggered" Inductance Values

THE conventional receiver with a signal-frequency amplifying stage having a tuned input and a tuned output circuit suffers under the disability that gain and selectivity increase as the receiver is tuned through a waveband from short to long wavelengths. This is clearly undesirable, particularly when high-fidelity reception is desired, and the object of this note is to suggest a modification of this type of circuit which can overcome the difficulty.

A typical circuit arrangement of a signal-frequency amplifying stage is shown in Fig. 1. The input and output circuits comprise the inductances  $L$  and  $L_1$  and the ganged

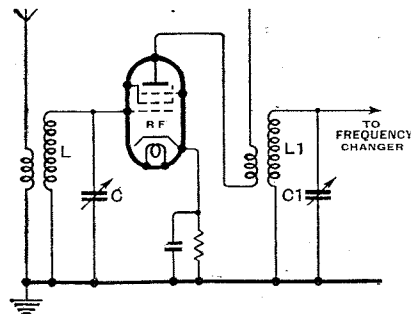

Fig. 1.—Signal-frequency stage of a typical superheterodyne receiver

tuning condensers  $C$  and  $C_1$ , together with their associated trimmers. The primaries of the aerial and intervalve transformers have a sufficiently high inductance to make them resonant at a frequency below the range of frequencies through which the receiver is to be tuned.

These cascaded circuits normally increase in selectivity as the frequency is reduced. Therefore, to provide a constant band-width, the circuits are mistuned at the low-frequency end of the broadcast band, which, for the neighbourhood of 600 kc/s. This is done by increasing the inductance of one of the coils as compared with the other. The difference between the resonant frequencies of the circuits, including the coils  $L$  and  $L_1$  at about 600 kc/s, may be made approximately 10 kc/s. Since the gain of the amplifier is normally higher at the low-frequency end of the range, due to the high-inductance primary, the mistuning tends to cause the overall sensitivity to be more constant over the whole range.

Referring to Fig. 2 (a), if the inductance  $L$  and  $L_1$  are aligned to the same frequency, the overall response of the tuning system at three selected frequencies will be as shown by the curves A, B and C, corresponding to 600, 1,000 and 1,500 kc/s respectively. If the maximum modulation frequency which is desired is indicated by the frequency range  $x$ , it will be seen that considerable attenuation will be obtained, particularly at the low-frequency end of the tuning range, resulting in the loss of fidelity.

Now, if the ganged condenser has identical sections for each circuit, and if the coils are also identical, except that they are adjusted in inductance so that the resonant frequencies are 10 kc/s apart when aligned at 1,500 kc/s, it has been found that the width of the modulation frequency band  $x$  will be substantially constant throughout the tuning range, as is indicated in Fig. 2 (b) by the curves D, E, F, again corresponding respectively to the tuning of the circuits to 600, 1,000 and 1,500 kc/s. It will be noted

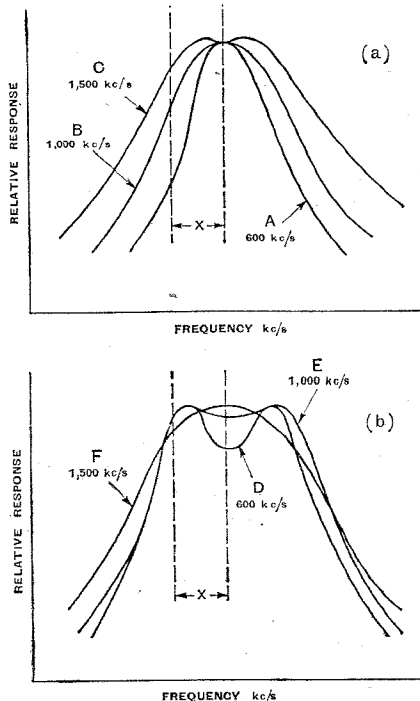

Fig. 2.—Response curves showing how the band-width of a normal RF stage varies with frequency over the broadcast band, and (diagram (b)) how sensibly constant width can be obtained by circuit misalignment

that the desired modulation band  $x$  falls well within the three curves without appreciable attenuation throughout the tuning range.

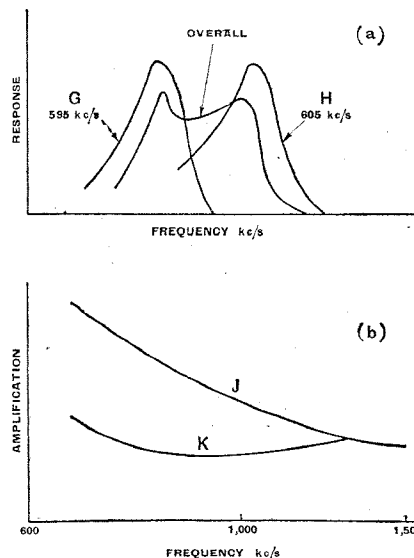

Fig. 3.—Characteristics of individual and "staggered" pairs of circuits under conditions described in the text

The effect of deliberate misalignment may be more readily seen by referring to Fig. 3 (a), in which the tuning response of the input circuit is indicated by the curve G and the tuning response of the anode circuit is indicated by the curve H. However, either of the circuits may be tuned to the higher frequency. In the present example, one circuit is tuned to 595 kc/s as indicated, and the other circuit is tuned to 605 kc/s, providing an overall response characteristic as a product of the two response characteristics which is indicated by the overall curve.

Fig. 3 (b) shows the overall RF amplification throughout the tuning range, the curve J being the response of the stage as aligned normally, while K represents the effect of "staggering" the circuits.

The circuits are aligned at the high-frequency end of the tuning range, say at 1,500 kc/s, by means of the usual shunt trimming condensers. These condensers should be as far as possible identical in capacity and capacity range variation, thereby simplifying the construction of the receiver and lowering the cost.

While this represents a departure

### Constant Band-width Tuning—

from previous practice and is substantially a reversal of certain methods previously employed in connection with radio receiving systems for providing variations in selectivity with tuning, it has been found to provide a sensibly constant band width in the tuning response of radio receivers adapted for high-fidelity reproduction.

It has the advantage that the variable tuning condensers employed may be made alike, the only departure from standard practice being the "staggering" of tuning inductance values in the successive cascaded circuits.

This method of obtaining constant band-width by the use of "staggered" circuits has been developed by the Radio Corporation of America.

recording company's studios, the name of the hall used for the session? This information, I think, would be useful to discriminating record purchasers.

Before finishing, I would greatly appreciate a little space to answer publicly several critical, even abusive, letters that have reached me directly. I fully recognised the controversial nature of my proposition at the present time, but anyone who troubles to read my first letter carefully cannot doubt that my sole purpose was to assist the attainment of full English supremacy in the field of gramophones. If other persons, presumably with different experience and more facts on the subject than I possess, believe that all English commercial recordings are already supreme, I am well content that my personal views should be thus refuted.

DONALD W. ALDOUS.

Torquay, Devon.

# LETTERS to the EDITOR

## The Editor Does Not Necessarily Endorse the Opinions of His Correspondents

### British and German Recordings

I HAVE read the letters of Mr. Aldous and Mr. Purser on the subject of gramophone recordings with much interest.

I agree with Mr. Aldous that the Telefunken recordings set a very high standard, which is rarely equalled, and never, as far as I am aware, surpassed by the English companies. This quality is difficult to define, but would seem to be a combination of atmosphere and perspective without loss of clarity, and cleaner recording of string tone. English recording of the string tone of an orchestra is generally rather rough, and deteriorates rapidly as the centre of the record is approached. Telefunken have overcome this difficulty. May I suggest that electrical or mechanical distortion may be the cause? The recordings may be lowered to a practically common level by manipulation of the tone control, which suggests that it is the harmonics of the English recordings which require cleaning up.

I use H.M.V. hypersensitive light-weight and Voigt pick-ups with 12-W triode output and a Voigt corner horn.

I have only two of the recordings mentioned by Mr. Purser—the "España" and the "Invitation to the Waltz." The "Chabrier España" has atmosphere, lacks perspective and suffers a slight loss of clarity due to echo. The "Weber Waltz" starts off very well, but the string tone deteriorates very much by the end.

I suggest that the Beethoven Leonora No. 1 (Toscanini), DB 3846, is better than either of the other records mentioned, but still lacks quite the atmosphere and perspective of the Telefunken.

The recent issues of the L.P.O. under Sir Thomas Beecham set a generally good standard, but could be improved on the lines indicated. The

"Beethoven Piano Concertos, Nos. 3 and 4," Saxon State orchestra, are also good. When we come to chamber music and the smaller orchestra, *vide* Mozart clarinet concerto, C3167-70, the English results are better.

I hope that the criticism of English recordings will prove helpful, and that we may soon enjoy the fruits of further technical development, because we have musicians and conductors worthy of the finest recordings.

G. T. GAMBLE.

Rickmansworth.

I AM very glad that my letter on German-quality recordings (February issue) has evoked a reply from such an authority as Mr. Wm. S. Purser.

There is much truth in Mr. Purser's point about the importance of certain auditoria reverberation characteristics (I mentioned this myself), but is it the complete explanation for the aurally satisfying Telefunken series? Please note the word "series," for I think that by not understanding my reference to the entire series or issues of Telefunken records Mr. Purser's questions, in his final paragraph, have arisen. *Of course*, given two sets of English and German records of equal merit, my choice would always be the former, but my selection of the German recordings as a criterion was not based only on individual records but on the high technical standard set by the whole series.

I regret that, being away from London at present, I am not able to refresh my impressions of the H.M.V. records listed by Mr. Purser, and so it would be unwise to comment on them, but an idea has occurred to me while reading the details of the concert halls used for these recordings: why not print on the labels of all orchestral and operatic recordings, made outside the

### Vibratory HT Generators

I SHOULD like to make the following comments on the article, "Vibratory HT Generators," in your March issue.

In the first place, it should have been pointed out that the addition of reed-energising control, even in a circuit which has the reed-energising contacts open in the quiescent condition, bears no relation to modern vibrators or contact wear rates with modern circuit arrangements. A great deal of progress has been made in this country in the design of circuit constants to prevent wear which in other circumstances is primarily due to thermionic effects during make and break. Thus it is normal to achieve constant performance beyond 2,000 hours, and this is confirmed by Government laboratory life tests.

In the article the statement appears, "the efficiency of the unit falling after 1,000 hours' use by from 80 per cent. to 50-70 per cent." Surely this should be read without the word "by." Actually, modern time efficiency is of the order of 90 per cent., and it is considered that even then efficiency has been sacrificed to ensure long life.

A more serious view may finally show the error of too hasty acceptance of reed-energising control.

The modern vibrator is designed to operate at normal vibration amplitude at its rated voltage. One is, therefore, faced with the alternative of either using more energising supply voltage or running at initially reduced efficiency in order to be able to insert energising control. The first method is inefficient, and leads to the possibility of over-excitation. The second

## Wireless World

### Letters to the Editor—

method, apart from reducing efficiency to the level of a worn unit for its whole life, leads to increased contact current, etc., in order to attain the same output as an "uncontrolled" unit, and thus actually increases the possibility of wear.

R. POLLOCK,  
Chief Engineer, Masteradio, Ltd.

### Our 30th Birthday

AS a reader of *The Wireless World* and its predecessor *The Marconi-graph* for the past 30 years, I think the enclosed photographs may be of interest to other readers.



THEN—Changes during the lifetime of *The Wireless World*: the first of these two photographs—

The earlier photograph, taken in 1912, is of myself with wireless apparatus made from hints contained in your pioneer publication. My first wireless instrument was made when a schoolboy in 1907, and was a Marconi filings coherer with bell tapper decoherer and small spark coil for room-to-room experiments. In the photograph can be seen a home-made Lodge-Muirhead mercury wheel coherer, crystal detector and large jam-jar wound as a tuning coil. Low-resistance phones were used with a transformer. The white cloth served as a light reflector.

The later photograph shows my station G2HF, minus the transmitting gear removed by the Post Office at the outbreak of war. Various experimental apparatus can be seen, such as remote control rack, disc recorder, steel wire speech recorder, morse tape recorder, oscilloscope, communication receiver, capacity and resistance bridges, etc.

In conclusion, may I extend birthday greetings and congratulations to *The Wireless World* and wishes for a very long successful run yet?

CECIL H. L. ANDREW.

Wellington, Somerset.

### The Future of Amateur Radio

IN connection with the comments made by the President of the Radio Society of Great Britain on my article,

"The Future of Amateur Radio," the following notes may be of interest to readers. It is also hoped that these facts will come to the notice of the Editor of that Society's official organ, in which was published a somewhat violent attack on my writings.

First, it may come as a surprise to the Society's executive, who apparently assumed that I had never even heard of the R.S.G.B., to learn that I have, for several years, been a member of the Society. Thus, the splendid work carried out both in peacetime and during the present war by the organisation is well known to me, as are the annual reports of the Society. I am unable, however, to see any reason why, being in possession of this knowledge, I should have refrained from putting forward suggestions as to the future.

Secondly, the explanation as to why no mention was made of the Society should be obvious. It was simply that if my personal views had been coupled to an eulogy of the R.S.G.B., readers would unquestionably have been given the impression that those views coincided with official Society policy. Further, it was known that, from time to time, details as to the Society's wartime plans had been fully reported in *The Wireless World*, and that any mention of them would have been in the nature of a repetition that would savour of Society propaganda.

I am certain that all R.S.G.B. mem-

bers cannot support what appears to be an attempt to discredit ideas simply because they do not emanate from the Council of the Society. If that organisation is to play an important role in negotiations with the G.P.O., it would seem a pity that its fine record should be marred by such an exhibition of petty egoism. "NAVIGATOR."

AS an amateur of 22 years' experience, and having held two radiating licences and being ex-principal of an evening radio school, I think I am qualified to criticise the letter from Mr. Pluck, published in your March issue.

I agree that the artificial aerial licence must be issued, but the holder should not be allowed to apply for a radiating licence until he has held the former for one year, and not three months as in pre-war days.

My personal experience of the amateur transmitter is that not more than 40 per cent. could pass an examination in radio theory; as for an 18-WPM morse test, I fail to see any logical reason for it. I would suggest that if the G.P.O. were to adopt Mr. Pluck's ideas the piracy of call signs would increase tenfold.

Mr. Pluck's reason for proposing that new licence holders operate on CW for the first three months is very obscure.

L. E. BAXTER, G8HG, R.S.G.B.  
Sale Moor, Cheshire.



—AND NOW.—of Mr. Cecil H. L. Andrew and his station was taken soon after we began publication. The second shows G2HF at the present time, minus the transmitting gear.

# Inductance Calculations

By S. W. AMOS, B.Sc.(Hons.)

*As Applied  
to Air-Cored  
Coils*

WE must begin this article by considering the definition of self-inductance. At school we were told that it was the total number of linkages of magnetic lines of force with conductors, when unit current is flowing in the circuit. Now for a long coil the magnetic field within it is given by:—

$$H = 4\pi ni \text{ lines per square centimetre.}$$

where  $n$  = number of turns per centimetre.

and  $i$  = current in absolute electromagnetic units.

This formula is only true provided that the medium in the centre of the coil has a permeability of unity, which is true for air. It is therefore assumed throughout this article that all coils mentioned are air-cored.

In wireless we are usually concerned with inductances of circular section. Suppose that the diameter of such a coil is  $d$  cms. and that its length is  $l$  cms. Then:—

$$\text{Total number of lines inside the coil} = 4\pi ni \times \frac{\pi d^2}{4}$$

$$\begin{aligned} \text{Inductance (total linkages for } i = 1) &= \pi^2 n^2 d^2 l \text{ absolute units.} \\ &= \frac{\pi^2 N^2 d^2}{10^9 l} \text{ microhenries } (\mu\text{H}), \end{aligned}$$

where  $N = nl$ , i.e.,  $N$  is the total number of turns. All measurements are still in centimetres.

## The Classical Formula

This is the formula for self-inductance usually found in most of the classical books on electricity. It is quite accurate, provided the length of the coil is great compared with its diameter, a condition which, unfortunately, few radio coils satisfy. It might work well for some short-wave RF chokes, which are often long and thin. In order to fix the limitations of this classical formula it may be mentioned that the error introduced in using it is less than 10 per cent. if the length of the coil is more than  $3\frac{1}{2}$  times the diameter.

In general the tuning inductances

of modern receivers are such that their diameter and length are of about the same magnitude. In these circumstances the use of the above formula will lead to large errors. However, the formula can be modified to give excellent results simply by multiplying it by a factor  $K$ , whose value depends upon the ratio of the diameter to the length. The formula for self-inductance thus becomes:—

$$\text{Inductance} = \frac{K\pi^2 N^2 d^2}{10^9 l} \mu\text{H.}$$

The values of  $K$  have been evaluated for many values of  $\frac{d}{l}$  by

Nagaoka. As an example for  $\frac{d}{l} = 2.4$

Nagaoka's factor is 0.4816, so that the self-inductance of a coil whose diameter is 2.4 times its length is less than one half of the value given by the uncorrected classical formula. It is worth noting in passing that this particular value of  $\frac{d}{l}$  gives maximum inductance for a given ohmic resistance of the winding. If a table of the values of Nagaoka's factor is available then the above formula may be used with complete satisfaction.

A more convenient formula for the inductances of short solenoids is the following:—

$$\text{Inductance} = \frac{N^2 r K}{10^3} \mu\text{H}$$

## CORRECTION FACTOR FOR COILS OF VARIOUS RADIUS/LENGTH PROPORTIONS

$\frac{r}{l}$	K	$\frac{r}{l}$	K
0.10	3.6324	0.90	19.5794
0.15	5.2337	1.00	20.7463
0.20	6.7102	1.10	21.8205
0.25	8.0747	1.20	22.8150
0.30	9.3389	1.30	23.7401
0.35	10.5135	1.40	24.6048
0.40	11.6079	1.50	25.4161
0.45	12.6306	1.60	26.1801
0.50	13.5889	1.70	26.9018
0.60	15.3380	1.80	27.5855
0.70	16.8984	1.90	28.2349
0.80	18.3035	2.00	28.8534

in which  $N$  is, as before, the total number of turns,  $r$  is the radius of the coil in centimetres and  $K$  is a factor which depends on the ratio  $\frac{r}{l}$ .

It will be readily appreciated that this is really a modification of Nagaoka's formula, specially designed to simplify calculations.

The accompanying table shows how  $K$  varies with  $\frac{r}{l}$  and in Fig. 1

these same values are illustrated in graphical form. By interpolation from this curve it is possible to estimate the value of  $K$  for any value of  $\frac{r}{l}$  from 0.1 to 2.

## Some Examples

The application of the formula can best be illustrated by taking some numerical examples. Let us imagine that a commercial medium-wave coil has 80 turns, wound on a former  $1\frac{1}{4}$  inches in diameter. The winding occupies 1 inch. To find its inductance we must first find the value of  $K$  either from the table, or, in this case, more conveniently from the curve of Fig. 1.

From Fig. 1, knowing that  $\frac{r}{l}$  in

this case is 0.625, we get  $K = 15.7$ . Alternatively, the value of  $K$  can be found from the table, using the principle of proportional parts. To do this suppose that the curve is straight between  $\frac{r}{l} = 0.6$  and  $\frac{r}{l} = 0.7$ .

Then:—

$$K \text{ for } \frac{r}{l} = 0.625 \text{ is given by } 15.338$$

$$+ 0.25(16.8980 - 15.3380) = 15.728$$

Remembering that  $r$  is in centi-

### Inductance Calculations—

metres, and that 2.54 cms. = 1 inch, we have:—

$$\begin{aligned} \text{Inductance} &= \frac{N^2 r K}{10^3} \\ &= \frac{80 \times 80 \times 0.625 \times 2.54 \times 15.73}{10^3} \\ &= 159.8 \mu\text{H} \end{aligned}$$

which is a normal value for a medium-wave coil.

It frequently happens when designing a receiver that a coil has to be constructed to have a particular

value of inductance. The following problem is of this type.

An all-wave set requires a short-wave tuning coil which, when in parallel with a 0.0005  $\mu\text{F}$  variable condenser, covers a waverange of about 13 to 50 metres. By putting  $C = 0.0005$  and  $\lambda = 50$ , in the usual formula  $\lambda = 1885\sqrt{LC}$  we find that the necessary inductance is 1.41  $\mu\text{H}$ .

By fixing the dimensions of the coil we can now calculate the number of turns required to give this in-

ductance. Suppose we decide upon a former diameter of  $1\frac{1}{4}$  inches and a winding length of  $3\frac{1}{2}$  inches. This gives  $\frac{r}{l}$  as 0.18 and reference to the

graph or the table shows the corresponding value of  $K$  as 6.12. Representing inductance by  $L$ , we have:—

$$L = \frac{N^2 r K}{10^3}$$

from which:—

$$N = \sqrt{\frac{L \times 10^3}{r K}}$$

Substituting the appropriate values:

$$N = \sqrt{\frac{1.41 \times 10^3}{0.625 \times 2.54 \times 6.12}}$$

which gives:—

$$N = 12$$

Thus if 12 turns of wire are wound on a  $1\frac{1}{4}$  inch diameter former so as to occupy  $3\frac{1}{2}$  inches, then the required inductance will be obtained. The turns will evidently have to be space-wound, with a gap of about a quarter of an inch between neighbouring turns.

In problems of this type on medium-wave coils the gauge of wire used should be so chosen that the calculated number of turns just occupy the allowed length of winding. Long-wave coils are usually layer-wound, but the formula for inductance still applies.

The author is indebted to Messrs. Macmillan and Co., the publishers of "The Dictionary of Applied Physics," for permission to reproduce the accompanying table.

### BOOK RECEIVED

**Broadcasting in 1940.** The story of British broadcasting in 1940, which is the story of a war effort in a new sphere, is reviewed in this B.B.C. annual. It tells the part played by broadcasting in this the first major war in which the armaments of the nations extend beyond land, sea and air into the ether. Whereas just prior to the war 44 hours of news in foreign languages were broadcast each week, it is recorded among many other interesting facts about the overseas service of the B.B.C. that this figure has been increased to 145 hours. In addition to sections covering various aspects of the Corporation's war effort, the reference section gives much helpful information, including advice on obtaining good reception in wartime. Pp. 128+31 pp. of illustrations. The British Broadcasting Corporation, The Grammar School, Scarle Road, Wembley, Middlesex. Price 2s. 4d. post free.

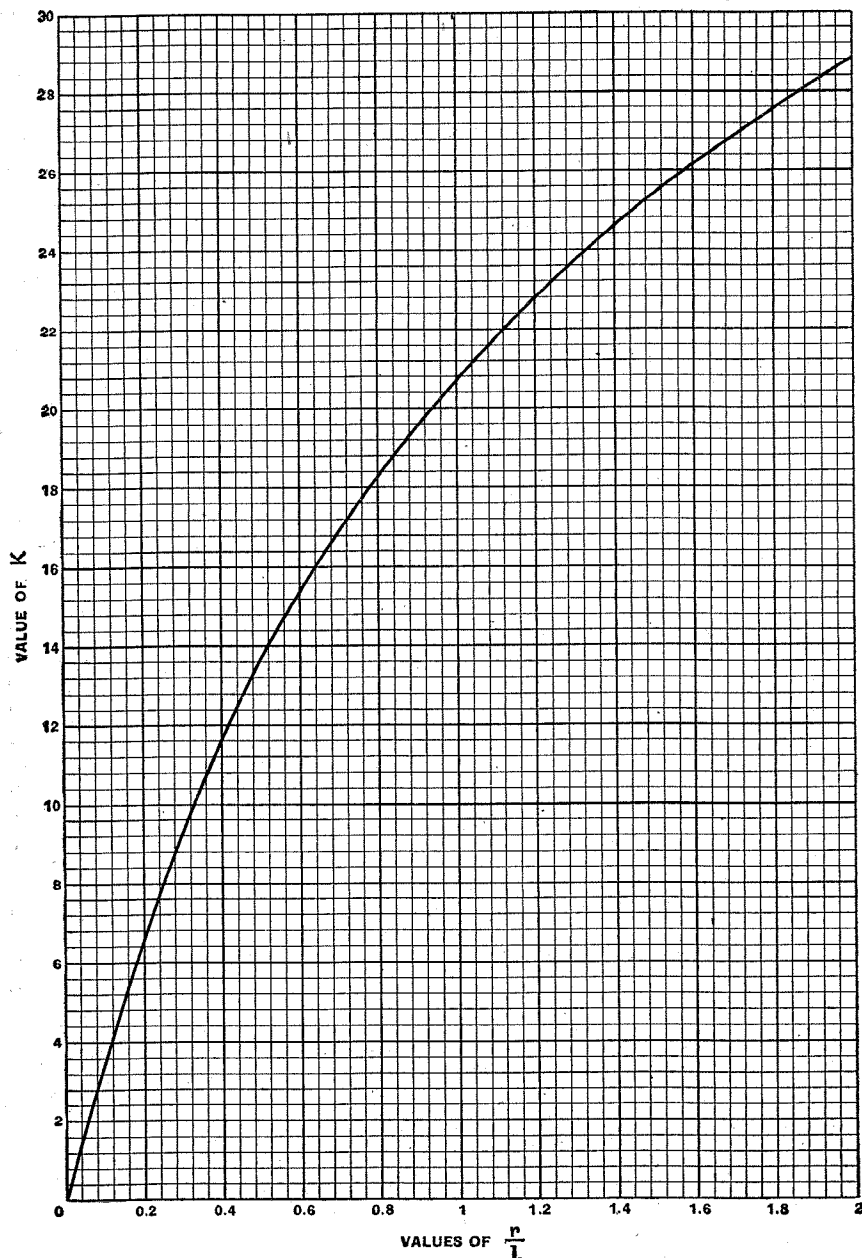

Fig. 1.—Curve for ascertaining the value of the correction factor  $K$ .

# THE WORLD OF WIRELESS

## WAR DEMANDS ON THE RADIO INDUSTRY

"Severe Limitation of Components and Valves"

**D**RASTIC restrictions in the quantity of wireless apparatus and valves available for domestic use is foreshadowed by the Board of Trade, which points out that manufacturers will have to play an increasing part in the war effort. The statement continues:

"Discussions have accordingly taken place between representatives of the industry and the interested Government Departments with a view to ensuring that the resources of the industry are available to the full for the production of radio sets, valves, and other components for essential purposes.

"It follows that there can no longer be available, except in very limited numbers, components such as valves required for the maintenance of domestic radio sets or new sets to replace those which go out of operation. In order to ensure that this reduction in supplies for home civilian requirements shall be effected on as orderly a basis as possible, the radio set and valve industries have been asked to work to a long term programme which will mean a severe limitation on the release of such components as valves for the domestic market.

"The extent to which such components as valves can be made available for maintenance purposes must, of course, depend in large measure on

the requirements of the fighting Services and the position is likely to vary from time to time.

"So far as export is concerned, special arrangements will be made to meet, so far as is possible, the demand for valves for maintenance purposes, and in part, at any rate, the demand for new sets."

## WAVELENGTH CHANGES IN THE U.S.

**T**HE revised list of frequency allocations issued by the U.S. Federal Communications Commission shows that 795 of the 883 medium-wave broadcasting stations will change their wavelengths at 3.0 a.m., E.S.T., on March 29th, in accordance with the North American Regional Broadcasting Agreement.

Stations unable to change their wavelengths on that date, owing to the difficulty which may be experienced in obtaining crystals for frequency control due to the huge demand for them, must remain silent until such time as they can operate on their new frequencies.

The agreement specifies that certain stations must use directional aerials. If, however, these are not completed by the prescribed date, the stations concerned will have to operate with sufficiently reduced power to avoid interference.

## TRAGIC DEATH OF FERRANTI CHIEF RADIO ENGINEER

**T**HE passing of Mr. Albert Hall, A.R.C.Sc., Wh.Ex., the chief radio engineer of Ferranti, Limited, at the age of 62, as a result of a road accident in which Mr. Gilbert Newbigging, one of his assistants, was also fatally injured, removes from the world of wireless a well-known engineer. Mr. Hall's engineering activities covered an unusually wide field, and his career was one of exceptional interest. It was in 1902 that he began his association with the late Dr. S. Z. de Ferranti in heavy engineering. He turned to the field of wireless in 1922, when Dr. Ferranti became interested in the subject. Wireless, in fact, became the dominating interest for the rest of his life, and since the death of his chief in 1930 Mr. Hall has held the position of chief engineer to the radio department of Ferranti. The sympathy of his many friends goes out

to his widow, his son (who is also on Ferranti's staff) and his daughter.



The late Mr. Albert Hall.

## COLOUR TELEVISION

Direct Pick-up Demonstrated in the States

**T**HE first demonstration of direct pick-up colour television in the U.S. was recently given to members of the Institute of Radio Engineers by the Columbia Broadcasting System. The scenes, which were picked up with a camera equipped with an Orthicon tube, were transmitted by coaxial cable from one building to another and received on three receivers; a standard television receiver adjusted to reproduce colour transmissions in black and white, a standard receiver adapted for colour reproduction, and a new table model colour television set.

Two important new features are incorporated in the new receiver. The first is the method of synchronising the colour disc in the receiver with the colour disc in the transmitter by utilising synchronising impulses from the transmitter. This means that reception of colour pictures will be possible when a receiver and transmitter are operated by power supplies of different frequencies. Heretofore it has been necessary to rely on the 60-cycle mains supply for synchronising the discs. The second feature is a simple but ingenious method of bringing in phase the colour disc so that the colours at the receiving end can be "locked" with those at the transmitter.

It will be remembered that Mr. Baird's demonstration of direct pick-up colour television was reviewed in our February issue.

## FREQUENCY MODULATION

More Commercial Transmitters Licensed

**I**T is pointed out in our American contemporary, *Broadcasting*, which, incidentally, recently changed from a bi-monthly to a weekly publication, that, whereas in amplitude-modulated broadcasting the station's power and frequency are the important factors for advertisers, the yardstick for frequency-modulated stations will be square miles of coverage. The writer stresses the fact that the best station in an area might well be the one using the lowest power if advantage had been taken of location, for by doubling the height of its aerial it is possible to increase a station's coverage or power equivalent fourfold.

FM transmitters were granted commercial operation by the U.S. Federal Communications Commission from the beginning of the year. At the end of



## Wireless World

January applications for nearly 30 FM transmitters had been approved by the F.C.C., and there were still approximately 50 applications pending, and interest in FM is growing apace.

The Columbia Broadcasting System has been granted a licence to erect an FM transmitter in the Salmon Tower in New York. Operating on a frequency of 48.7 Mc/s with a designed coverage of 8,500 square miles, it is estimated it will serve a population of twelve millions. The cost will be approximately \$160,000.

### B.B.C. SHORT-WAVE NEWS

FIVE new wavelengths have recently been employed by the B.B.C. in its short-wave transmissions. They are GRS, 42.46 metres (7.065 Mc/s), recently introduced for the Forces programme; GRR, 49.38 metres (6.075 Mc/s), now used for the Home Service; and GRT, 41.96 metres (7.150 Mc/s), GRU, 31.75 metres (9.450 Mc/s), and GRV, 24.92 metres (12.040 Mc/s), employed in the European and World Services.

The transmission of news in English in the European and World Services take place at the following times (B.S.T.), and, at the time of going to press, on the following short wavelengths.

0030	...	49.59.*			
0100					
0245		49.10,	31.32,	31.25,	25.53.
0530					
0715	...	31.55,	31.32,	31.25,	25.53,
0900	...	49.59,*	41.49,*	31.55,	30.96,*
				19.82,	19.66,
				19.60,	16.84.
1200	...	31.25,	25.53,	19.82,	19.66,
				16.86,	13.97,
				13.92.	
1400	...	25.53,	19.82,	19.66,	16.86,
				13.97,	13.93,
				13.92.	
1430	...	49.59,*	41.49,*	25.38,*	25.29.*
1700	...	31.75,	31.55,	25.53,	16.84,
				13.93,	13.92.
1900	...	41.96,	31.25,	25.53,	19.82,
				19.66,	
2145	...	31.25,	25.53,	25.38,	25.29.
2300	...	49.59,*	41.49,*	30.96,*	
2345	...	49.10,	31.32,	31.25,	25.53.

Those marked with an asterisk are employed in the European Service.

### "PRAISE TO WHOM . . ."

AMERICANS have been loud in their praise of the B.B.C. staff since the announcement of the bombing of Broadcasting House. Referring to the occasion when Bruce Belfrage was reading the news, the editor of *Broadcasting* writes: "Like the captain of a foundering ship, the announcer stayed on the job. The men riding the gains stuck to their posts. Had the announcer indicated alarm, or the engineer pulled the plug, the audience might have been terrorised."

"To broadcasters the world over, the bombing of Broadcasting House carries a message of deepest significance. The broadcasting station, in modern warfare, is a military objective. And the broadcast is an arm of the military establishment, no less re-

sponsible for the public welfare than the man in uniform."

The secretary of the American Radio Relay League, writing in a recent issue of *QST*, referred to the unconquerable spirit of the British amateur transmitter as portrayed in the *T. & R. Bulletin*. In spite of the handicaps of war, "he is determined to have his amateur radio and to pursue it to the utmost that circumstances permit. He keeps his hand in and plans for a better day. . . . We extend to them encouragement, congratulations, bravos."

### FROM ALL QUARTERS

#### R.M.A. Council

At an extraordinary general meeting of the Radio Manufacturers' Association on February 20th, the executive council of 12 members for the ensuing year was elected. Of the twelve companies represented on the council eight are set manufacturers and four component manufacturers. The council normally consists of 21 members, but as a



Mr. J. H. Williams, R.M.A. chairman.

means of expediting decisions in the present circumstances it was agreed at the annual meeting to reduce the number to twelve. Mr. J. H. Williams, of Cossors, and Mr. M. M. Macqueen, of the G.E.C., were elected chairman and vice-chairman respectively.

#### Swiss People's Set

THE Swiss Administration of Posts, Telegraphs and Telephones has ordered the manufacture of a people's receiver which costs 128 Swiss francs. It is a 4-valve superheterodyne covering the medium-wave band only, and is housed in a small bakelite cabinet. According to details given in the *Bulletin of the Union Internationale de Radiodiffusion*, the receiver gives an undistorted output of 2 watts.

### Moscow's Short-wave Transmissions

AN ever-increasing number of frequencies are being employed by the U.S.S.R. for its oversea transmissions from Moscow. The task of checking the wavelengths used for the transmission of news in English for inclusion in our feature giving these details is made considerably harder by the fact that the announcer does not give the actual wavelengths used, but the bands in which the transmitters are operating. It has, therefore, been found necessary to give similar details only in our list of transmissions of news in English from abroad given on the next page.

### Servicemen's Postal Course

THE National Association of Radio Retailers has sponsored a postal course of training for servicemen which has been prepared by Mr. Paul D. Tyers. The course, which has been reduced to a reasonable minimum and yet covers the essential ground, is available to any radio retailer or his staff at an inclusive fee of £3 3s.

### America's Listeners

ACCORDING to figures published in our American contemporary, *Radio To-day*, 29,397,000 homes in the United States have broadcast receivers; moreover, approximately eleven million of these also have a second set. Together with the eight million car radio receivers in use, there are approximately 48,000,000 sets in the United States. Of the 49 states, New York heads the list with 3,455,000 wireless-equipped homes and Pennsylvania comes second with 2,430,100.

### R.M.A. War Standards

THE Radio Manufacturers' Association has recently issued "Recommended War Standards" covering materials for use in the insulation, interleaving and impregnation of windings. The objects are to effect economies, to restrict the number of grades, finishes and sizes of materials, and to suggest substitutes for those materials which may be scarce.

### Radio Gas Mask

A GAS mask equipped with a short-wave radio telephone having a range of a few hundred yards was recently demonstrated to the Ontario Civil Defence Committee.

### "Radio Magic"

THE many applications of thermionic valves and photo-electric cells to-day in science, industry and everyday life are discussed in the programme known as "Radio Magic" broadcast, by electrical transcription, from WNBI, 17.780 Mc/s (16.87 metres) every week, usually at 6.30 p.m. B.S.T. on Sundays. Recently the 63rd programme of the series, which is run by Dr. Orestes H. Caldwell, former Federal Radio Commissioner and editor of our U.S. contemporary, *Radio To-day*, dealt with the re-allocation on March 29th of broadcast channels under the Treaty of Havana, when the wavelengths of nearly

# Wireless World

## The World of Wireless—

800 United States stations will be affected.

### Canadian News

CANADA'S recently completed 7.5-kW short-wave station at Vercheres, Quebec, is now operating on a frequency of 6,160 kc/s. The station is intended to serve the French speaking communities in remote areas of the Quebec Province which are outside the service area of the existing network of medium-wave stations. The transmissions, although experimental, are radiated for 16½ hours a day. The station, which has the experimental call sign CBFW, is at present employing a non-directional vertical aerial.

The wavelength changes in N. America scheduled for March 9th will affect sixty Canadian stations.

At the end of the last fiscal year

Canada had 1,397,165 licensed listeners, which is an increase of 3.8 per cent. The greatest increase was shown in Nova Scotia, where it was 7.4 per cent. In Alberta, however, a slight decrease was shown, namely, 1.5 per cent.

### Training in Servicing

THE Edinburgh education authorities have announced that they are prepared to launch the scheme recently proposed by the Edinburgh branch of the Scottish Radio Retailers' Association to train boys and girls in wireless servicing. The classes are being organised in co-operation with the Association in an endeavour to meet the demand created by the entry of so many servicemen in the Forces.

### Indian Listeners

THE latest figures available for the number of licences in India gives a total of 117,555. According to *Science and*

*Culture* (Calcutta), the number of listeners in India is 3.3 per 10,000 of the population and is compared to England's 3 per cent. (approx.). The writer says "The Government of India has evidently failed to realise the immense importance of broadcasting . . . it is no longer a luxury; it is a necessity in the cultural life of a nation."

### "What! No Radio!"

A CLEVELAND, Ohio, \*citizen, driving along a suburban avenue, stopped his car to offer a curbside a ride down town. Many drivers thereabouts pick up thumbs who look as if they might be neighbours. This one, with one foot on the running board, looked inside the car, then stopped. "What! No radio!" he said, "I'll wait for another car. Thanks just as much."—*Broadcasting*.

## NEWS IN ENGLISH FROM ABROAD

### REGULAR SHORT-WAVE TRANSMISSIONS

Country : Station	Mc/s	Metres	Daily Bulletins (B.S.T.)	Country : Station	Mc/s	Metres	Daily Bulletins (B.S.T.)	
<b>America</b>				<b>Manchukuo</b>				
WNBI (Bound Brook) ..	17.780	16.87	4.0†, 6.0.	MTCY (Hsinking) ..	11.775	25.48	8.0 a.m., 10.5.	
WBOS (Millis) ..	9.570	31.35	11.45.	<b>Nova Scotia</b>				
WCBX (Wayne) ..	9.650	31.09	9.55‡, Midt.‡.	CHNX (Halifax) ..	6.130	48.94	10.45.	
WCBX ..	11.830	25.36	7.30‡.	<b>Newfoundland</b>				
WCBX ..	17.830	16.83	2.0, 3.0, 5.0†, 5.30‡.	VONG (St. John's) ..	5.970	50.25	11.15.	
WGEO (Schenectady) ..	9.530	31.48	8.30‡, 10.55‡†.	<b>Sweden</b>				
WGEA (Schenectady) ..	15.330	19.57	1.0, 2.0‡, 6.0, 7.45.	SBO (Motala) ..	6.065	49.46	10.20.	
WPIT (Pittsburgh) ..	15.210	19.72	6.0.	<b>Thailand</b>				
WRUL (Boston) ..	11.790	25.45	8.15‡†, 9.30‡†.	HSP5 (Bangkok) ..	11.715	25.61	12.45	
WRUL ..	15.350	19.55	8.15‡†, 9.30‡†.	HS6PJ ..	19.420	15.77	12.45	
WRUL ..	6.040	49.67	9.30*.	<b>Turkey</b>				
<b>Australia</b>				TAP (Ankara) ..	9.465	31.70	7.15.	
VLQ (Sydney) ..	9.615	31.20	8.0 a.m., 8.0.	TAQ ..	15.195	19.74	12.15.	
VLQ5 ..	9.680	30.99	1.30, 4.30, 7.15, 10.30.	<b>U.S.S.R. (Moseow)</b>				
VLQ2 ..	11.870	25.27	12.45, 6.0, 7.15.	49-metre band ..	—	—	} 1.0 a.m., 7.30, 9.0, 11.0.	
VLQ7 ..	11.880	25.25	8.0 a.m., 3.0, 8.0, 11.0.	41 ..	—	—		
VLQ8 ..	17.800	16.85	7.0 a.m.	31 ..	—	—		
<b>China</b>				25 ..	—	—		} 5.0, 7.30.
XRVC (Chungking) ..	7.508	39.96	11.30 a.m., 12.10, 9.30, 10.30.	19 ..	—	—		
<b>Finland</b>				16 ..	—	—	} 7.33 a.m., 12.0 noon.	
OFD (Lahti) ..	9.500	31.58	12.15 a.m., 7.15, 10.15.	<b>Vatican City</b>				
OFE ..	11.780	25.47	12.15 a.m., 8.40 a.m., 7.15, 10.15.	HVJ ..	6.190	48.47	8.15.	
OIE ..	15.190	19.75	12.15 a.m., 7.15, 10.15.	<b>Yugoslavia</b>				
<b>French Equatorial Africa</b>				YUA (Belgrade) ..	6.100	49.18	10.25.	
Brazzaville ..	11.970	25.06	8.45.	<b>LONG- AND MEDIUM-WAVE TRANSMISSIONS</b>				
<b>Greece</b>				kc/s    Metres				
Athens ..	9.935	30.19	8.45.	<b>Egypt</b>				
<b>India</b>				Cairo ..	1,348	222.6	6.50, 10.10.	
VUD3 (Delhi) ..	9.590	31.28	1.30, 4.50.	<b>Ireland</b>				
VUD4 ..	11.830	25.36	9.0 a.m., 1.30, 4.50, 6.15.	Radio-Eireann ..	565	531	1.40, 6.45‡, 10.5†, 10.10‡.	
VUD3 ..	15.290	19.62	9.0 a.m.	<b>U.S.S.R.</b>				
<b>Iran</b>				Moscow I ..	172	1,744	11.0.	
EQB (Teheran) ..	6.155	48.74	7.30.					
<b>Japan</b>								
JLT (Tokio) ..	6.190	48.47	10.30.					
JVW ..	7.257	41.34	10.30.					

It should be noted that at this time of the year changes of wavelength are frequently made and readers are, therefore, advised to try alternative wavelengths. The times of the transmission of news in English in the B.R.C. Short-wave Service are given on the preceding page.

All times are p.m. unless otherwise stated. \* Saturdays only. ‡ Saturdays excepted. † Sundays only. ‡ Sundays excepted.

# "Mystery" Record Players

## Details of the Wireless Link in American Radio Gramophones

THE use of wirelessly actuated remote-control tuning for radio receivers has aroused a new interest in low-power transmitters for the purpose of linking various adjuncts to the main radio set. These miniature radio transmitters enable a receiver to be located in one room and to reproduce, through its loud speaker, recordings that are on the turntable of the record player in the same room or in another part of the house without any wire connections between them.

In America this type of record reproducer, known as a phono-radio unit or "magic" wireless record player, has enjoyed popularity for some time, and all the large radio manufacturers have marketed models. These units consist of the usual pick-up and motor with turntable with the addition of a valve oscillator built-in. The oscillating circuit is designed to produce oscillations in the broadcast band, and usually this carrier, which is modulated by the audio-frequency output of the pick-up, is adjustable over 100 or 200 kc/s by means of a padding condenser, to permit the reception of the signal at a point where no powerful station is present. Although a separate modulator valve can be used, generally a single valve is utilised for a dual purpose and electron-modulation is employed. High-frequency stability of the circuit is essential to avoid distortion in the reproduction.

A typical circuit of these remote record players is shown in the accompanying diagram, which is a design

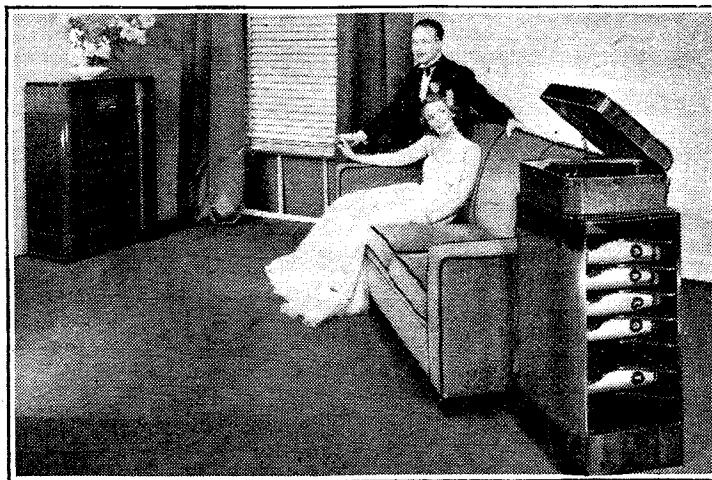

REAL RADIO GRAMOPHONES, with no tangible connection between the record reproducing equipment and the wireless set, are now widely used in America. Their operation is described in the accompanying text.

incorporated in a unit supplied by the Allied Radio Corporation, of Chicago.

The aerial (radiator) may be a metal plate inside the record player cabinet or may be integral with the mains "flex," although in this case a short protruding length of wire is generally provided. If this wire is placed near to and parallel with the lead-in of the radio receiver, optimum results will be obtained. It will function, however, from 25 to 50 feet from the set. Volume level is controlled either by the control on the main receiver or that in the pick-up circuit on the record player.

The outstanding advantages of such units are that records can be played through *any* radio receiver without disturbing a single internal connection or using special adaptor-plugs, as well as the ability to place the record player in a convenient position for operation without the need for trailing wires. By inserting a microphone instead of the pick-up "home broadcasting" is possible.

D. W. A.

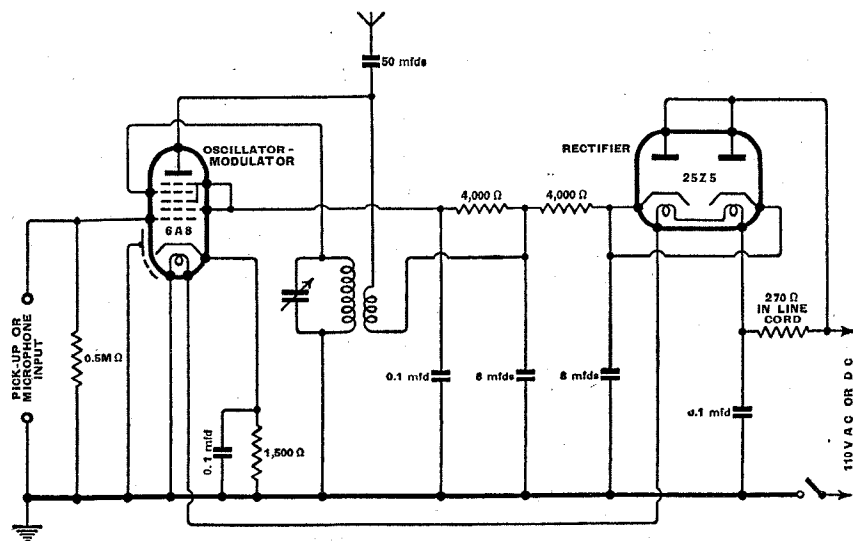

Typical circuit arrangement of the oscillator-modulator, which is mounted with the record playing equipment.

### Identifying Aircraft

A NOVELTY produced by our associate journal *Flight* is a pocket-size transparent identification chart of German aircraft comprising 18 semi-silhouettes and 41 line diagrams printed on two celluloid cards connected by a swivel eyelet. The chart measures  $4\frac{1}{2} \times 5\frac{1}{2}$  in. and costs 1s. 6d., post free. The revised identification charts of British and German aircraft, which are printed on eye-letted and corded cards measuring  $22 \times 14\frac{1}{2}$  in. cost 1s. each, plus 6d. each for postage.

# Overhauling Old Receivers

## Rejuvenating Veterans for Wartime Listening

**T**HE rapidly dwindling stocks of radio instruments in dealers' shops is creating a demand for any type of old receivers that can be brought up to a sufficiently acceptable standard for present-day reception. Some suggestions for dealing with such sets seem to be opportune.

It is not intended to discuss the means whereby old sets may be modernised. In any case, such work is not often satisfactory from any point of view.

First, it should be appreciated that the results from old receivers, even after they have been rejuvenated, will probably in no way compare with those that can be obtained from modern receivers, though the results from them will give satisfactory reception for the period of the war. After all, with the distortion present in the majority of transmissions, it is not much good demanding high-quality reproduction from a receiver, and so long as the instrument gives general satisfaction for reception of B.B.C. programmes and the more powerful foreign stations one must be content.

### External Overhaul

The first thing to do when the old receiver is put on the bench for its examination is to give it a thoroughly good clean up and to make it presentable from an external point of view. With the many cabinet refinishing kits on the market to-day it is quite an easy matter to renovate cabinet work and to get rid of most of the minor scratches and disfigurements, but major repairs should be put in the hands of an experienced cabinet maker if the extra expense is considered worthwhile.

The commencing electrical test will, naturally, be a trial of the instrument to see just what results, if any, can be obtained. Test valves may be used for replacement purposes if results are poor, but it

By  
"SERVICE"

Valves are scarce, and so, when making replacements, it will sometimes be necessary to use a type requiring a new holder. Guidance in making wiring alterations was given in *The Wireless World Valve Data* Number, May, 1940.

should be emphasised that, unless a valve is definitely unserviceable, it should not be replaced with a new one. It is in the national interest to conserve the existing stocks for use as replacements against a complete breakdown rather than to employ them in order to get the last ounce out of a fairly satisfactory receiver.

In the case of old valves which are completely unusable and which are no longer listed as being available for replacement purposes, a study of *The Wireless World Valve Data* Supplement will indicate a suitable modern equivalent which can be used, even if this does mean taking out the old valve-holder and fitting a more modern type.

Modern valves are far more efficient than their prototypes, and if instability occurs due to this it may be necessary to do a little "doctoring" in the way of reducing the anode voltages or by introducing de-coupling components where necessary. It is always advisable to endeavour to get rid of instability in this way rather than to desensitise circuits by putting various resistances across, or in series with, them; which in the case of RF or IF circuits will not only deaden the circuit but will also lower the already possibly poor standard of selectivity.

With the valve circuits operating satisfactorily, attention may next be directed to doing any necessary

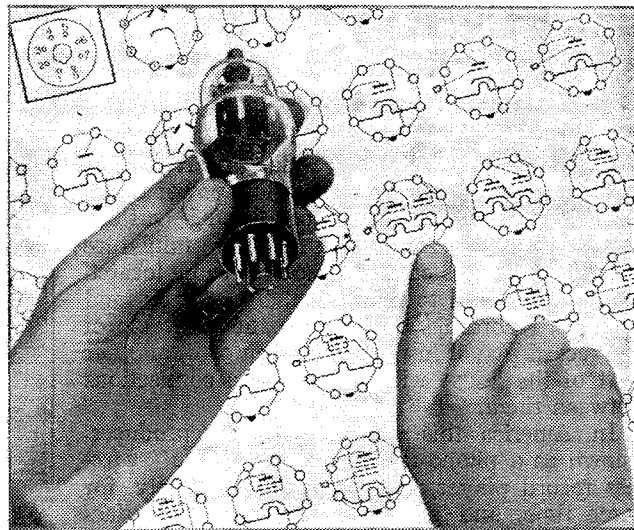

trimming and re-alignment. It may be found that, due to the increased sensitivity of the circuits, instability may again arise, and it will have to be dealt with on the lines already suggested. It is impossible to re-gang or re-align an unstable receiver, otherwise the whole question of instability could be left to this stage of the overhauling; therefore, the preliminary steps taken for reducing instability due to the introduction of new valves may be of a temporary nature only, to be made final when the sensitivity of the receiver as a whole has been brought up to as high a standard as possible.

### Electrolytic Condensers

One point which will be obvious from the start of the examination of the model will be the condition of any electrolytic condensers which may be in the chassis. It is quite probable that a number of these will have come to the end of their useful life and may be responsible for instability where de-coupling condensers are concerned, and hum in the case of smoothing condensers. In some instances it may be found that after a little use the condenser re-forms and is still capable of further service, but if there is any likelihood of short-circuiting, especially where indicated by an overheated mains transformer, they should be replaced.

## Wireless World

### Overhauling Old Receivers—

In this state of affairs a replacement is good policy as it may save the more costly replacement of rectifying valves and mains transformers.

Where a multiple block is concerned and only one portion of it has broken down, it is not essential to replace the whole block but just to cut the faulty unit out of the circuit and to wire in an external condenser of the required capacity and correct working conditions. The extra condenser may be mounted in some convenient position on the chassis or even on the inside of the cabinet, and wired into the circuit as neatly as possible.

### Switch Contacts

Mechanical items may now be considered, such as noisy wave-change switch contacts and volume controls. Regarding switches, resetting the contacts and cleaning them with one of the switch cleaning liquids available to the service engineer will put the component in good condition, but noisy volume controls are not so easily disposed of.

In the case of wire-wound components, the cleaning of the slider and the wire with which it makes contact, together with the resetting of any springs acting on the slider,

will quieten the action of the control. A touch of lubricant on the wire is often beneficial. The graphite contact type of control is not so easy to deal with.

Before condemning the track, the contact to slider and its internal connections should be examined and cleaned when they are obviously dirty, but if the graphite track itself is pitted and rough the only course open is the rather dubious one of rubbing it over lightly with a soft lead pencil.

The resistance value will be changed by so doing, but it may not be serious, and the elimination of the noise will be worth while. A replacement of the component will naturally overcome the trouble but, as already pointed out, present stocks should not be drawn on for an old receiver unless it is essential for its functioning.

Tuning condensers can also give rise to noise. If there is any dirt between the vanes and the earth clips at the end of each section, they should be cleaned, reset and lightly lubricated.

Finally, all wiring should be examined, and any rotted insulation made good and suspicious joints resoldered. The loud speaker may require re-centring, and any dirt cleaned out of the speech coil gap.

### The "Fluxite Quins" at work

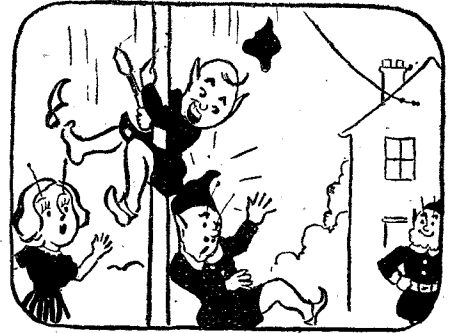

"Down I come—look out there below!"

Cried OI, as he landed on OH.

"Don't stand there and stare,

I'd no FLUXITE up there,

And this aerial needs soldering, y'know!"

See that FLUXITE is always by you—in the house—garage—workshop—wherever speedy soldering is needed. Used for 30 years in Government works and by leading engineers and manufacturers. Of Ironmongers—in tins, 4d., 8d., 1/4 and 2/8.

Ask to see the FLUXITE SMALL-SPACE SOLDERING SET—compact but substantial—complete with full instructions, 7/6.

Write for Free Book on the art of "soft" soldering and ask for Leaflet on CASE-HARDENING STEEL and TEMPERING TOOLS with FLUXITE.

## BOOKS ON WIRELESS

*issued in conjunction with "The Wireless World"*

	Net Price	By Post
"FOUNDATIONS OF WIRELESS," by A. L. M. Sowerby, M.Sc. Second Edition Revised ... ..	5/-	5/6
"RADIO LABORATORY HANDBOOK," by M. G. Scroggie, B.Sc., A.M.I.E.E. (Second edition in preparation) ... ..	10/6	11/1
"WIRELESS SERVICING MANUAL," by W. T. Cocking, A.M.I.E.E. Sixth Edition ... ..	6/-	6/6
"HANDBOOK OF TECHNICAL INSTRUCTION FOR WIRELESS TELEGRAPHISTS," by H. M. Dowsett, M.I.E.E., F.Inst.P., M.Inst.R.E. Sixth Edition Revised ... ..	21/-	21/9
"WIRELESS DIRECTION FINDING," by R. Keen, B.Eng. Hons. Sheffield, A.M.I.E.E. Third Edition ... ..	25/-	25/9
"RADIO DATA CHARTS," by R. T. Beatty, M.A., B.E., D.Sc. Second Edition ... ..	4/6	4/11
"TELEVISION RECEIVING EQUIPMENT," by W. T. Cocking, A.M.I.E.E. ... ..	8/6	9/-
"RADIO INTERFERENCE SUPPRESSION," by Gordon W. Ingram, B.Sc. ... ..	5/-	5/4
"LEARNING MORSE," Fifth Edition ... ..	6d.	7½d.
"RADIO DESIGNER'S HANDBOOK," Edited by F. Langford Smith, B.Sc., B.E. (Reprint in preparation) ... ..	8/6	9/1
"THE WIRELESS WORLD" GREAT CIRCLE PROJECTION MAP ... ..	2/-	Post free

*Obtainable from Leading Booksellers and Railway Bookstalls or by post (remittance with order) from*

ILIFFE & SONS LTD., Derset House, Stamford Street, London, S.E.1

*TO CYCLISTS! Your wheels will NOT keep round and true unless the spokes are tied with fine wire at the crossings AND SOLDERED. This makes a much stronger wheel. It's simple—with FLUXITE—but IMPORTANT.*

## THE FLUXITE GUN

is always ready to put Fluxite on the soldering job instantly. A little pressure places the right quantity on the right spot and one charging lasts for ages. Price 1/6, or filled 2/6.

FLUXITE LTD.  
(Dept. W.W.),  
BERMONDSEY  
STREET, S.E.1

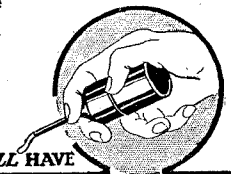

ALL MECHANICS WILL HAVE

# FLUXITE

IT SIMPLIFIES ALL SOLDERING

Test Report

# Philips Model 206A

Table Model Superhet for AC Mains (3 Valves + Rectifier).

Price (Including Purchase Tax) £10 4s. 2d.

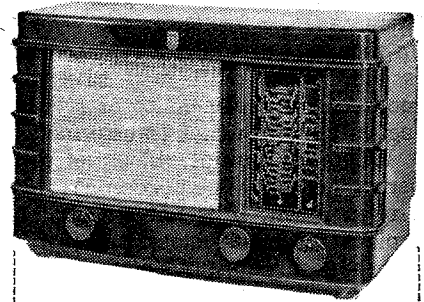

## WAVERANGES

Short	.. ..	16.7 - 51 metres
Medium	.. ..	186 - 585 metres
Long	.. ..	708 - 2,000 metres

**D**ESIGNED to make the most of the broadcast transmissions available in wartime and to do this with the maximum economy of essential materials, this neat little receiver covers three wavebands and can be used as a transportable with its internal capacity aerial.

The most obvious mark of the wartime set is the moulded bakelite cabinet, but there are many ingenious expedients in the chassis which reduce the amount of material required without prejudice to the performance.

**Circuit.**—The triode hexode used in the frequency changer stage is of a type designed to give stable operation on short waves with the minimum of frequency drift. The oscillator section is magnetically coupled and the anode circuit is tuned. Magnetic coupling is also employed between the aerial and the first tuned circuit. The IF wave trap circuit is connected in series with the input to the grid of the frequency changer valve instead of in its more usual position in the aerial circuit.

An intermediate frequency of 470 kc/s is employed and both windings of the output IF transformer are tapped down to feed the AVC and signal diodes. Adjustment of the IF

circuits is effected by movement of their iron dust cores.

The AVC circuit is unusual and is of more refined design than one would expect to find in a set of this type and price. The control for the frequency changer is provided by a separate diode from the primary of the output IF transformer, and is parallel-fed to the grid. Control for the IF stage is taken from the signal rectifier circuits and is series-fed.

Detector, AVC and output stages are combined in the same valve, and negative feedback is applied by including the loud-speaker winding in the cathode return lead of the pentode.

Resistance-capacity smoothing is used for the HT supply, and the output valve takes its current directly from the first reservoir condenser. The omission of a smoothing choke seems to be a justifiable economy as residual hum is negligible.

**Performance.**—For a set of its size the 206A has a remarkably lusty voice. The reproduction has an incisive quality which is calculated to penetrate any amount of background noise, whether this originates in the transmission or in the room where the set is being used. As a result the

intelligibility of weak and distant transmissions is considerably enhanced and the total number of stations available is equal to that of many sets of much more pretentious specification.

The loud speaker tends to favour frequencies in the upper middle register, and to ensure a balanced acoustic output accurate tuning is rather more important than in most sets. The band width of the IF stage is quite narrow, and selective emphasis of sidebands resulting from slight mistuning is not likely to pass unnoticed.

The set is very lively on all three wavebands, and brings in every worthwhile programme, including the Americas when conditions are favourable. Tuning on short waves remains stable, and what little image interference there is would pass unnoticed by the average user.

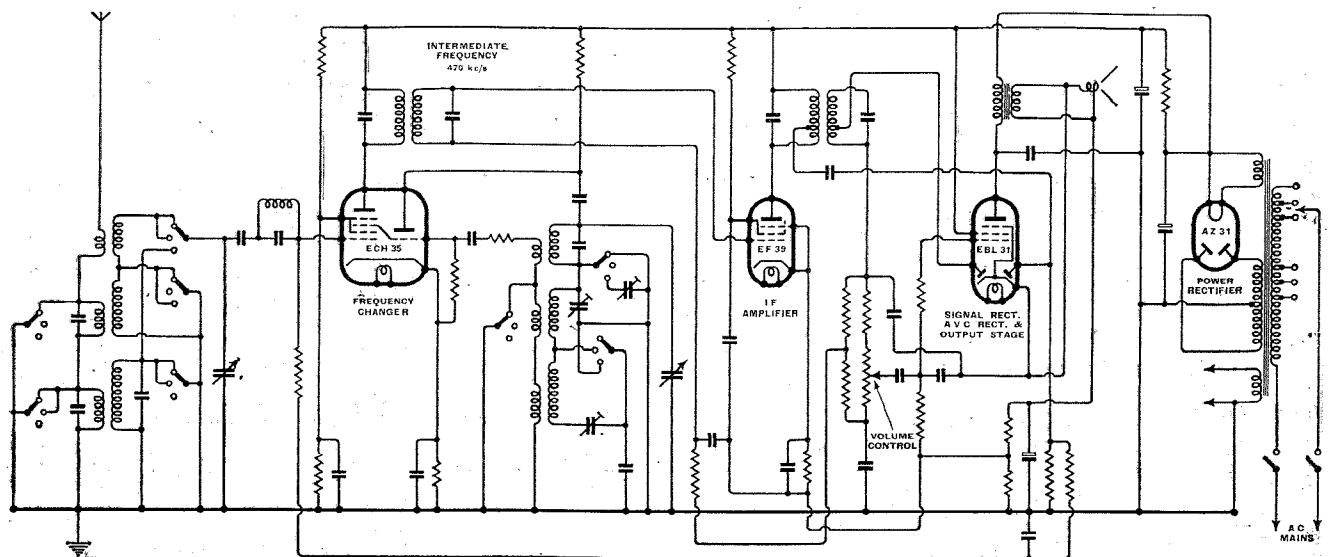

Circuit diagram of the Philips Model 206A. Separate AVC circuits are provided for the frequency changer and IF stages and negative feedback is applied in the output stage.

## Philips Model 206A—

**Constructional Features.**—The cabinet is a strong but light moulding with a very good finish, and its measurements are  $15\frac{1}{2} \times 9\frac{5}{8} \times 7\frac{1}{2}$  inches. The vertical tuning scale is clearly marked and well illuminated with a diagram at the bottom of each wave-range denoting the appropriate setting of the waverange switch.

It is rather surprising, in view of the volume and clarity of the reproduction, to find that the loud speaker magnet housing is only  $1\frac{1}{4}$  in. in diameter and  $1\frac{1}{2}$  in. deep. The two-gang tuning condenser is of standard de-

sign, but the vanes may be of brass instead of aluminium in some models.

The internal aerial consists of a sheet of foil on the underside of the top of the cabinet. It is always in circuit and contact is made by a spring tongue.

Mains voltage adjustment is effected by the usual neat Philips rotary plug, and tappings are provided for mains voltages between 100 and 250 volts. The consumption of the set is approximately 60 watts at 220 volts.

**Makers.**—Philips Lamps, Ltd., Century House, Shaftesbury Avenue, London, W.C.2.

## Short-wave Receiving Conditions

PROSPECTS FOR APRIL

(COMMUNICATED BY THE ENGINEERING DEPARTMENT OF CABLE AND WIRELESS, LTD.)

SHORT-WAVE conditions in February were less settled than has been the case during recent months. Ionosphere storms were in evidence on February 3rd, 5th to 9th inclusive, and 13 to 26th inclusive (but excluding 18th and 19th). Their intensity was greatest and their effect most widespread during the period from the 13th to the 26th; however, the occurrence of such conditions at this particular period was not entirely unexpected (see p. 50 of the February issue of this journal, published on January 20th).

Transatlantic channels were among those most severely affected by these storms, and on many occasions poor conditions set in during the late evening and progressively deteriorated throughout the night until the late forenoon, at which time a rapid recovery was usually exhibited.

Sudden ionosphere disturbances of the Dellinger type occurred as under—these and other times given in this report being GMT on the 24-hour clock notation:—

(A) February 14th, at 1845.

(B) February 26th, at 1915.

(C) February 27th, at 1545.

(D) February 28th, at 0930 and 1445.

The duration of these disturbances ranged from a minimum of about seven minutes for that on February 14th to a maximum of about one hour for each of the two disturbances on February 28th.

The effects of (A) and (B) were, in general, confined to transatlantic channels, whilst those of (C) and (D) were more widespread.

Particulars of the broadcast bands,

which, it is considered, should prove most reliable during April under normal conditions of propagation at the times stated for five selected routes are given below; these may serve as a guide when considering the possibilities of reception from places not too remote from those specified.

Attention is drawn to the fact that a number of factors, for example (a) transmitter power, (b) efficiency of aerials at both the transmitting and receiving ends, and (c) ionosphere abnormalities, may often result in better reception being obtained on wavebands other than those quoted. Moreover, transmission on each of the stated bands may not necessarily be available.

**Buenos Aires:** Midt., 25 or 31 m; 0300, 31, 41 or 49 m; 0600, 31 m; 0900, 25 m; 1100, 16 or 19 m; 1500, 16 m; 1800, 16 or 19 m; 2100, 19 or 25 m.

The period from 0600 to 1000 may present difficulties; in addition, signals during the early afternoon are likely to be weak and accompanied by echo.

**Montreal:** Midt., 31 or 41 m; 0300, 41 or 49 m; 0500, 49 m; 0800, 25, 31 or 41 m; 1100, 19 or 25 m; 1500, 16 or 19 m; 1900, 19 or 25 m; 2200, 25 or 31 m.

Under normal conditions the period which is expected to be least favourable for reception over this route is from 0600 to 1100.

**Java:** Midt., 25 or 31 m; 0600, 0900 and 1200, 16 m; 1400, 16 or 19 m; 1600, 19 or 25 m; 1800, 25, 31 or 41 m; 2100, 31, 41 or 49 m.

Signals are not expected to be of commercial value on any wavelength between about 0100 and 0500, and

# BULGIN

## for CHOKES

### NATIONAL EFFORT

IN these times, in many directions, needless to say, we are directing our main efforts and supplies towards the requirements of the Government Services.

However, some supplies of components are still available for Radio Servicing, but should delays occur we know our friends will appreciate the difficulties which at present arise from day to day.

We would point out that delays can be minimised and often avoided if alternatives are, wherever possible, specified when ordering.

Prices are being kept as low as possible despite increased costs in every direction. Meanwhile you still have the best and largest range of radio products in the United Kingdom to choose from.

## THANK YOU!

### A SELECTION OF H.F. CHOKES.

Inductance in $\mu$ H	$\Omega$	List Nos.	List Price
8000	30	H.F.30	3/-
5000	20	H.F.29	3/-
2500	10	H.F.28	3/-
80000	400	H.F.33	3/6
75000	180	H.F.34	2/6
30000	90	H.F.32	3/6
16000	60	H.F.31	3/6
198000	400	H.F.8	2/9
15000	360	S.W.69	3/-
500000	1000	H.F.108	4/-
200000	400	H.F.35	3/6
900	0.55	H.F.26	4/-
400	0.255	H.F.36	10/6

All Prices Subject; War increase, + 16 2/3%

## FOR ALL RADIO COMPONENTS

Advert. of A. F. BULGIN & CO., LTD.  
BYE PASS ROAD, BARKING, ESSEX.

Tel.: RIPpleway 3474 (4 lines).

### Short-wave Receiving Conditions—

those during the period from 0600 to 1000 may be weak.

**Nairobi:** 0300, 31 or 41 m; 0600, 16 or 19 m; 1000 and 1400, 16 m; 1700, 16 or 19 m; 2000, 19 or 25 m; 2300, 25, 31 or 41 m.

Signals are expected to reach a low level for two or three hours centred on 1000.

**Tokio:** Midt., 25 or 31 m; 0500, 16 or 19 m; 1800 and 1100, 16 m; 1400, 19 or 25 m; 1700, 25 or 31 m; 2000, 31 m.

During the period from 0700 to

1100 echo signals may be prevalent under certain conditions of ionisation. It is considered unlikely that signals will be of commercial value during the period from 0100 to 0400.

At the time of writing this report the trend of conditions suggests that the following periods may be susceptible to a relatively high disturbance factor: the beginning and end of April and for a few days in the vicinity of the 9th and 17th of the month.

# RANDOM RADIATIONS

## Useful Tip

**I**N case you didn't know it, here's a tip that may come in handy at times. When you're moving from place to place and want to get a receiving set quickly into action to hear the news or some specially attractive item in the programmes, you often can't contrive an aerial, but you can always manage some kind of earth. At no great distance from a B.B.C. station many sets, particularly those whose screening is not too good, will give very fair reception—by which I mean that they will make a news bulletin audible and intelligible—if you plug the earth lead into the socket provided for it and leave the aerial socket vacant. But you may find that you get far better reception by reversing the process: that is, connect the earth lead to "AE" and leave "E" free. An instance occurred the other day when we moved into a newly requisitioned house—the abode, until something went off with a bump pretty close to it, of the local parson. "Is our new address the Vicarage or the Rectory?" queried one subaltern. "Not the Victory but the Wreckage," says I. Anyhow, we found honest-to-goodness 230-volt 50-cycle AC when we got there at five minutes to one. Our receiver was hastily unpacked and plugged in. No aerial available, but we tucked an earth lead into one of the clips holding the lead-sheathed lighting wires. Reception was very poor till we did the "human aerial" stunt, taking it in turns to stand with a finger on the aerial socket. That worked wonders. Then it occurred to me to try sticking the earth plug into the aerial socket. There was a most gratifying improvement—so gratifying that I was surprised to find that the sheathing was well earthed.

## By "DIALLIST"

### The External LS

**T**HERE'S a lot to be said for not having the loud speaker built into the set. Amongst the drawbacks of having it inside the same cabinet are these. Unless the set is a console or a radiogram there is often no room for anything but a midget LS; the cabinet is apt to be boomy, particularly if it's made of thin plywood; vibration is likely to be communicated to the valves, with evil effects should any have microphonic tendencies. What I like to do, if a small receiver has an arrangement for silencing its own speaker, is to use it to run a separate reproducer, with the built-in LS out of action. Many people have good "separate" loud speakers put by, and it's always worth while, when one is available, to try out the method I've suggested. At the present time I am using a small set, which gives very poor reproduction on its own speaker. I'm not going so far as to say that it is perfect when an external LS is used alone; but I can say that the improvement is enormous. For one thing you get rid of much of the drumminess and that is a big step in the right direction.

### Mixed Fare

**A** RATHER remarkable experiment was tried recently in America by the G.E.C. of that country. The voice of a speaker was conveyed over long distances simultaneously by every method known to science. It was sent out on the ultra-short waves as an accompaniment to television; it went over the landline telephone; it was broadcast on the medium waves and the short waves; it was carried by a

beam of light. The radio and light-beam frequencies used ranged from 790 kilocycles to 750 million megacycles. Interesting without a doubt, even if it was a bit of a stunt. It serves, anyhow, to show just how far we've got in our harnessing of electromagnetic radiation for communication purposes—and just how far we haven't. I expect that, like me, you often wonder what the men and women of the twenty-first century will think of the broadcasting and the television of the twentieth. I'm sure that in any event some of the dogmatic statements in our textbooks will give them cause for fine, hearty laughter!

## A Lot to Learn

If you don't believe the sentiment expressed in that last sentence, blow the dust from a few of the veterans in your textbook shelves and spend a little time in skimming the pages devoted to such subjects as aerials, fading and the propagation of short waves. And by veterans I don't mean only the tomes published thirty or more years ago. You'll find some very pretty statements made categorically (though now completely exploded) in works that don't go back much over ten years! And don't forget that it's not so very long since the short waves were handed over to the amateurs because the Post Office authorities had satisfied (!) themselves that they could never be used for communication except over distances too short to be of any real value. The practical application of wireless is still barely forty years old. We've learnt a lot, but there's the heck of a lot to learn still.

■ ■ ■

## 'Phone Talks from the Radio LS

**S**OME time ago I told you of one of the most amazing coincidences that has ever happened to me. I was sitting in my room one evening writing an article and in the next room my wife was listening to the Regional programme. I'd just written that I'd never had an instance of induction between the Post Office telephone and the radio receiver in my own home when the 'phone bell rang—a long-distance call. When it was over my wife came into the room and repeated word for word one sentence that I'd said to my correspondent. She had been astonished, during a brief interval in the wireless programme, to hear my voice coming strongly from the loudspeaker. It had never happened before, and, curiously and curiously, it has never happened since,



## Wireless World

though there has been no change in the wiring or the positions of either the telephone or her wireless set. I told the story to a P.O. engineer the other day. He said that they had often to deal with very puzzling induction or pick-up effects of this kind. Sometimes they receive bitter complaints, but can find no evidence of any such effects when they come to investigate. They make every test they can think of and nothing happens. The householder agrees that everything seems to be in order and that is apparently the end of the matter. But very often it isn't, for the trouble occurs again at intervals. My P.O. friend told me that they had had cases of strong intermittent induction which it had taken weeks of work to cure, and a few which had begun and remained completely baffling.

### More Power to U.S.

IT'S good to know that our overseas short-wave services now have far greater power behind their transmissions than they had before the war. It is needed. Years ago when the dictator countries began putting up high-powered SW stations it was obvious that they were up to no particular good. When the war broke out they had almost everything they needed for flooding the world with propaganda. As country after country possessing powerful SW stations was overrun they acquired sufficient transmitters for all purposes—including a reserve kept for jamming any broadcasts from other people that weren't to their taste.

### Forward, Free Grid!

THERE are several much wanted radio gadgets, attachments or what not which have so far failed to materialise. I feel sure that if I call Free Grid's attention to them he will invent them without delay. The first is a speed regulator—or kind of decelerator button—to enable you to slow down the fellow who is speaking in a foreign language just too fast for you to be able to follow him. It might be known as the Degabblor. But better still would be the Degibberer, a circuit which on receiving an input of Swahili, Eskimo, Singalese, or Double Dutch would automatically rectify it into plain English. Then there's the Autosteadier, for taking the wobble out of sopranos, and the Antiduffer, for making pudding-y contraltos less pudding-y. But best of all would be

the Remote Loudspeaker Snuffer. The purpose of this handy and welcome device would be to enable you to silence the loud speaker which has been bellowing from three doors away for hours just in time to save your reason.

### Asking For It!

ONE wonders what the German broadcasting authorities really expected to receive when they made their recent short-lived offer to pay the cost of candid cablegrams to the Fatherland from citizens of the U.S.A. To judge from some of the samples that I saw quoted the results were not what, for some queer reason, they had expected that they would be. The experiment appears to have cost them £10,000 or more before it was brought to a rather hasty end. It isn't often that a fellow places himself in the ideal position for a kick in the pants, and then not only invites its delivery but even offers to pay for it. The strange thing is that the Germans should not have foreseen what was coming to them when they issued the invitation. That they didn't was shown by the rather pained surprise of the Berlin announcer, when he said in aggrieved tones that those who sent cablegrams hadn't always shown the warm admiration for him and his that he could have wished.

### From German Journals

THE prevailing difficulty of obtaining journals from abroad, and especially those published in enemy or enemy occupied countries, has greatly enhanced the value of the monthly feature of *The Wireless Engineer* devoted to abstracts from and references to articles recently published in the technical journals of the world. In the March issue, which contains over 300 abstracts and references, the space devoted to abstracts from articles recently published in German journals in some cases amounts to more than a page, whereas an important article in English in a journal likely to be readily accessible may possibly be dismissed with no more than a parenthetical addition to the title.

The March issue of our sister journal also contains original articles dealing with the measurement of modulation depth; the use of the linear rectifier as an indicator for the measurement of shot and thermal noise; and the band-pass effect in electric wave-filters terminated in negative impedance.

Published on the first of the month, *The Wireless Engineer* is obtainable to order through newsgents, or direct from our publishers at Dorset House, Stamford Street, London, S.E.1, at 2s. 8d., including postage.

## VORTEXION 50w. AMPLIFIER CHASSIS

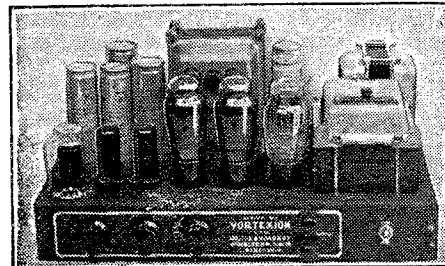

A pair of matched 6L6's with 10 per cent. negative feed-back is fitted in the output stage, and the separate HT supplies to the anode and screen have better than 4 per cent. regulation, while a separate rectifier provides bias. The 6L6's are driven by a 6F6 triode connected through a driver transformer incorporating feed-back. This is preceded by a 6N7 electronic mixing for pick-up and microphone. The additional 6F5 operating as first stage on microphone only is suitable for any microphone. A tone control is fitted, and the large eight-section output transformer is available in three types—2-8-15-30 ohms; 4-15-30-60 ohms or 15-60-125-250 ohms. These output lines can be matched using all sections of windings and will deliver the full response (40-18,000 c/s) to the loud speakers with extremely low overall harmonic distortion.

CHASSIS with valves and plugs .....	£17 10 0
Or complete in black leatherette cabinet with Collaro turntable, Piezo P.U. and shielded Mike Transformer .....	£22 10 0
Plus 20% War Increase on above prices. Goodmans P.A. Speakers in stock.	
Paper Maché Horn Speakers .....	£6 6 0
Moving Coil Microphones .....	£5 5 0
Chromium Microphone Stands from .....	10 6

Many hundreds already in use for  
**A.R.P. & GOVERNMENT purposes**

### 15w. AC & 12-VOLT DC AMPLIFIER

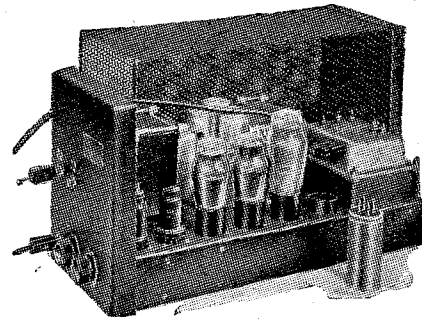

TYPE CP20

This small Portable Amplifier operating either from AC mains or 12-volt battery, was tested by "THE WIRELESS WORLD," October 1st, 1937, and has proved so popular that at Customers' demand it remains unaltered except that the output has been increased to 17.2 watts and the battery consumption lowered to 6 amperes. Read what "The Wireless World" said:—

"During tests an output of 14.7 watts was obtained without any trace of distortion so that the rating of 15 watts is quite justified. The measured response shows an upper limit of 18,000 c/s and a power of 30 c/s. Its performance is exceptionally good. Another outstanding feature is its exceptionally low hum level when AC operated even without an earth connection. In order to obtain the maximum undistorted output, an input to the microphone jack of 0.037 volt was required. The two independent volume controls enable one to adjust the gain of the amplifier for the same power output from both sources, as well as superimpose one on the other, or fade out one and bring the other up to full volume. The secondary of the output transformer is tapped for loud speakers or line impedances of 4, 7.5 and 15 ohms." Prices: Plus 20% war increase.

AC and 12-volt CHASSIS with valves, etc. ....	£12 12 0
Or in Rexine Case with Collaro Motor, Piezo P.U. and Mike Transformer .....	£17 17 0
AC only CHASSIS with valves, etc. ....	£8 18 6
Or in Rexine Case with Collaro Motor, Piezo P.U. and Mike Transformer .....	£14 0 0
Gauze Case for either chassis, 12/6 extra.	

**Vortexion Ltd., 257, The Broadway, Wimbledon, S.W.19. Phone: LIBerty 2514**

# UNBIASED

## 1911 And All That

By FREE GRID

SINCE *The Wireless World* has now attained the ripe old age of thirty, an age at which our legislators of 1918 deemed that women had grown sufficiently in wisdom and stature to be given the vote, it is a fitting opportunity for me to disclose a little scheme which I have been turning over in my mind for some time past. In brief, the scheme is one which will enable citizens to recognise those among their fellows who have raised themselves above the level of ordinary men by bearing the heat and burden of the day for thirty long years inasmuch that they have been steadfast readers of *The Wireless World* throughout that period, hoping, like Mr. Micawber, that something better might turn up.



The Editor in 1911—

Unlike Mr. Micawber, however, their hopes have not been disappointed, as in pre-war days each Thursday morning—and now for the duration, each 20th of the month—has brought them something better than the previous issue. I was almost tempted to say *invariably* brought, but I have always been a great stickler for the truth, and I am not unmindful of the fact that the Editor has had his weak moments when, like Ulysses, he has had his mind distracted by the seductive call of the sirens, and this has been reflected—even if ever so slightly—in the subsequent issue of the journal.

I think that I cannot do better than to issue to every reader of more than twenty years' standing a suitable old *Wireless World* tie, a bar being added to the tie for every year over twenty. Those having the bare tie without bars will be entitled to a courteous raising of the hat, the marks of respect increasing according to the number of bars, while a full thirty years man will be entitled, I think, to a pension for life. Even if he doesn't get it, he deserves it.

Apart from the question of the bars, I have not made up my mind concerning a suitable design for the tie, and am hoping that one or two of you have some suggestions. One idea is to have

a sketch of the Editor as he was in 1911, and as he is in 1941. With regard to the latter sketch I can, of course, call on the talent of the best-known artists, but with regard to the former, I am forced to rely on the sketch which I publish herewith, drawn, I believe, by a scholastic contemporary, who subsequently became a leading light on the staff of a rival wireless journal, long since defunct.

You will, of course, realise that even when I have the design completed it will be quite impossible for me to approach any manufacturer about the question of producing the ties unless I can also put him on to a supply of the necessary silk, which the war has rendered so scarce. I think that the most hopeful source of supply is silk stockings, as these, I am told, can be quite easily unpicked and the silk used for other purposes. Most of you, no doubt, have female friends who possess far more pairs of silk stockings than they ought to have at this time of national need, and so it need not weigh heavily on your consciences if you go rummaging in their drawers and see what you can find. I shall be anxious to hear from you, as if you cannot help me, the whole scheme may have to be postponed until after the war.

## Radio Recordograms Wanted

NO doubt wireless manufacturers, like all the rest of us, are giving a great deal of their time and energy to the national effort, their steam yachts converted into auxiliary cruisers, and their racehorses sent across to Libya to pick up a few hints and tips about speed from the Italians. Nevertheless, they still seem to have the time and materials to produce a few wartime models, but it is a source of astonishment to me that so far they have not marketed the one type of set that would be of real use in these times.

I refer, of course, to the combined receiver and automatic recorder which would enable us to obtain full value out of the B.B.C. every evening of the year, for it is giving away no information to the enemy to point out that on many evenings reception of the B.B.C. programmes is not as clear and free

from distortion as it might be.

I think I can justly claim to have found the proper solution to this problem of poor radio evenings if the manufacturers will only do their part and produce the correct sets. All that is necessary is that the B.B.C. should radiate all its evening programmes on a special wavelength during daylight hours, these being picked up by our sets in our absence, and recorded on a built-in Blattnerphone outfit ready to entertain us in the evening. If the B.B.C. would radiate these programmes at certain stated hours during the day our recording receivers would switch themselves on at that time by means of a built-in programme clock, of the type which is even now available for switching sets on or off, at any desired time.

I myself have gone half-way to the practical carrying out of my scheme, for I have already built myself a receiver-recorder of this type, and invariably set the instrument to switch itself on at sundry times during the day in order to bottle certain items which take my fancy when I listen to the B.B.C. daily programme parade, and which my daytime absence from home would otherwise make me miss.

## Out of the Depths

WHENEVER I feel down in the mouth, I always think of Jonah, and remember that he came up all right, and, in any case, even at the worst, he was in a thundering good air-raid shelter with an ample stock of fresh provisions on tap, and only needed a good portable for DF work

in order to make his life entirely self-contained. I mention this fact because the other day I was gazing rather disconsolately at the cold and silent screen of my television receiver and reflecting that it was eighteen months since it had sparkled with the life and gaiety of a B.B.C. programme. Suddenly I thought of Jonah, and my

spirits rose in company with him. I reflected that the war will at least have solved the problem of long-distance television for us, as after it there will be an ample supply of barrage balloons available for supporting our television aerials.



—and in 1941.

# RECENT INVENTIONS

A Monthly Selection of the More Interesting Radio Developments

## SHORT-WAVE VALVES

RELATES to the electrode arrangement of a valve designed to handle very high frequencies, that is, frequencies such that the time taken by the electrons to pass from one electrode to another forms an appreciable fraction of a complete cycle. As shown, in the case of a triode, all three electrodes take the form of coaxial cylinders with connecting leads at both ends. In addition, the usual arrangement is reversed, and the earthed or "earthy" cathode K is placed outside the grid G and anode A. Since it would be difficult—or undesirable—to make the coated cathode as a continuous cylinder, it is sufficient to wind a helix or zig-zag of wire around a cylindrical former.

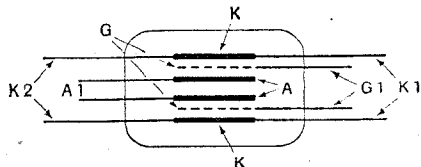

Electrode arrangement of UHF valve.

When used as an amplifier, the input is applied to the concentric transmission line K1, G1, formed by the continuation of the cathode K and grid G on one side of the glass bulb, whilst the output passes through the concentric line formed by the anode and cathode extensions A1, K2, on the opposite side of the bulb. The arrangement of the cathode outside the anode provides a larger emissive surface than usual, and so helps to increase the conductance of the valve.

The M-O Valve Co., Ltd., and M. R. Gavin. Application dates February 20th, 1939, and January 24th, 1940. No. 525378.

## SHORT-WAVE AERIALS

IN order to present a constant impedance over a wide range of signalling frequencies, the aerial consists of one or a pair of conical or horn-shaped radiators coupled to a feed line which gradually expands or merges into the narrow end of each horn. In other words, the cross-section of the feed line is gradually increased until it forms part of and has the same dimensions as the narrow part of the radiator. This ensures a gradual change in the shape of the electromagnetic field, due to the currents carried by the feeder to that of the spherical wave actually radiated, and so avoids any abrupt change of impedance at the coupling point. The conical radiators may be made of sheet metal or of a cage of wires.

Marconi's Wireless Telegraph Co., Ltd. (communicated by P. S. Carter). Application date, 15th February, 1939. No. 525159.

## ELECTRON MULTIPLIERS

AMPLIFIER tubes of the kind which depend upon the liberation of secondary electrons from specially coated "target" electrodes are found, in practice, to have a comparatively short life, owing to the tendency of such targets to lose their emissivity. This is believed to be largely due to the evaporation from the cathode of the tube of Barium atoms which settle upon the target electrodes and so gradually build up a contaminating layer.

The invention is designed to offset such deterioration by inserting capsules of activating material inside the tube and in close proximity to the coated electrodes. The capsules are provided with heating filaments through which a current is passed from time to time sufficient to cause some of the active material to "vaporise" and to be re-deposited on the sensitive electrodes, thereby giving them a fresh lease of life.

Kolster-Brandes, Ltd., and C. N. Smyth. Application date, 7th February, 1939. No. 524776.

## TELEVISION IMPROVEMENTS

TELEVISION and sound signals on ultra-short wavelengths are particularly subject to the type of interference caused by car ignition, though of the two the crackling produced in the sound channel is more disagreeable than the distortion effect on the viewing screen.

The remedy suggested is to use a single short-wave carrier and to impose upon it, first the sound signals by frequency modulation (which is less susceptible to the type of interference in question), and then the picture signals by ordinary amplitude modulation. The frequency-modulated carrier is passed through a "limiting" valve or equivalent device which smooths out any accidental amplitude variations produced during the first modulating process before the carrier is passed on to the amplitude-modulator for the picture signals. The line and frame synchronising impulses are applied by reducing the carrier-wave amplitude to zero for the appropriate intervals. The system is also stated to reduce the band-width normally required to transmit a sound-and-vision programme through the other.

H. E. Kallman. Application date, 24th February, 1939. No. 525628.

The British abstracts published here are prepared with the permission of the Controller of H.M. Stationery Office, from specifications obtainable at the Patent Office, 25, Southampton Buildings, London, W.C.2, price 1/- each.

## SHORT-WAVE AMPLIFIERS

IT is known that the control, at high frequencies, of an electron stream by a charged grid necessarily involves some waste of power in the grid circuit, even when the grid is charged so negatively that electrons cannot make impact with it. Electrons which pass through the apertures of the grid set up an induced or influence current, which, owing to the time taken by the electrons to travel across the space separating the cathode from the grid, either leads or lags the applied grid voltage. This means that a "real" AC component is flowing in the input circuit and is consuming power.

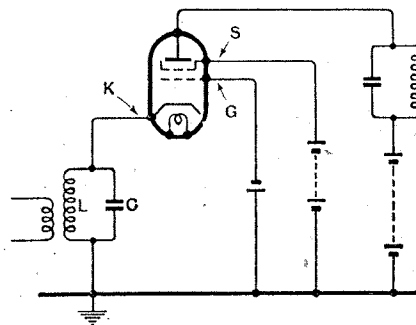

Cathode input circuit.

If the working frequency is made sufficiently high, the current induced in the manner stated may lag the input current by more than 90 deg., so that a negative component is present, which then serves to reduce damping. This is called the inversion effect, but at very high frequencies it is not practicable to use it with an ordinary tuned input circuit.

It can, however, be made to give good results if the input circuit L, C is, as shown in the Figure, inserted between the cathode K and ground, and if both the control grid G and screening grid S are also earthed through suitable sources of biasing voltage.

Telefunken Ges. für drahtlose Telegraphie m.b.h. Convention date (Germany) March 3rd, 1938. No. 525951.

## PRESS-BUTTON TUNERS

IN a switch-tuned set each selector button, once it has been pressed to tune to a given station, is automatically made free to revolve so that it can then be used to effect continuous tuning.

In its normal or inoperative position the button is locked against rotation by the two ends of a spring. As it is pushed in, to set the circuits into tune for the desired station, the holding parts of the spring pass through a slot and free the shaft of the button so that it can be used to operate the moving magnetic core or other variable-tuning device.

E. K. Cole, Ltd., and R. Kemp. Application date, 17th February, 1939. No. 525611.

This Taylor combined Mutual Conductance Valve Tester and Multi-range Meter is beyond compare. It is the most versatile instrument you could wish for.

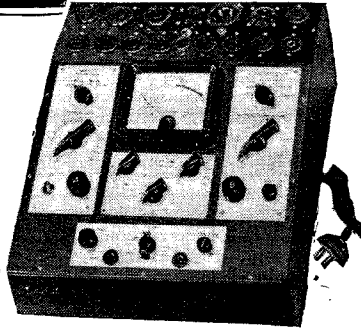

**What it will do!**

**ACCURATELY MEASURE** the Mutual Conductance of practically every type of British, American and Continental radio receiving valve.  
**TEST EVERY VALVE** under correct working conditions.  
**17 VALVE HOLDERS** of different types are incorporated for testing Midget Deaf-Aid, Mullard side contact, American Octal, Locktal and Bantam bases in addition to all standard types of valves.  
**MULTI-ELECTRODE VALVES.** Each section can be tested independently.  
**TEST CATHODE LEAKAGE.** Calibrated scale shows leakages as high as 10 megohms.  
**TEST FILAMENT CONTINUITY AND SHORTS.** All are indicated by a lamp mounted on the panel.  
**MEASURE : D.C. VOLTS, CURRENT AND RESISTANCE.** The Taylor 4 1/2 in. square type moving coil meter is calibrated for these measurements.  
**Volts :** (7 ranges) 0-0.1 to 0-1,000 volts.  
**Amps :** (5 ranges) 0-0.5 m.a. to 0-2.5 amps.  
**Resistances :** (4 ranges) 5 ohms to 10 megohms.

**TAYLOR MODEL 47 VALVE TESTER**

is of all-metal construction, black crystal finish. Supplied complete with book of instructions, Valve Manual for over 1,500 different types. Grid connecting lead and pair of test leads with prods.

Operates on A.C. 200/250 v., 40/100 cycles.

**£16-16-0**  
(no purchase tax payable)

A fully descriptive technical Brochure of this instrument, available on request.

**PORTABLE MODEL with tool locker £17.11.6.**

BRITISH MADE. FULLY TESTED. GUARANTEED SIX MONTHS.

**TAYLOR ELECTRICAL INSTRUMENTS LTD.**  
419-422, Montrose Avenue, SLOUGH, Bucks.  
Telephone: SLOUGH 21381.

P. R. MALLORY & CO. Inc.  
**MALLORY Vibrapack**

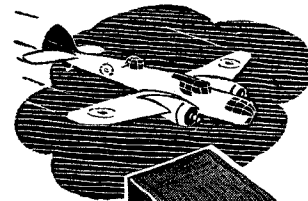

GIVES FLYERS ONE FOOT ON THE GROUND

The widespread popularity of Mallory Vibrapacks for use in aeroplane radio transmitters is additional evidence of the truth of the Mallory slogan "Perfect Portable Power". Pilots know they can rely upon Mallory Vibrapacks for a dependable signal and low battery drain. Mallory Vibrapacks provide the ideal source of plate voltage wherever commercial electric power is not available, whether it's in the air or on the ground. Vibrapacks are available for operation from both 6 and 12 volt batteries with outputs up to 300 volts at 100 ma. of easily filtered D.C. In addition the low voltage models are ideal for converting 110 volt receivers for 6 volt battery operation. Radio receiver manufacturers are finding Mallory Vibrapacks ideal for use in their export model receivers. There are 21 special manufacturers' type following standard types for use in vibrapacks available in addition to the aircraft, boat, police, automobile and similar services.

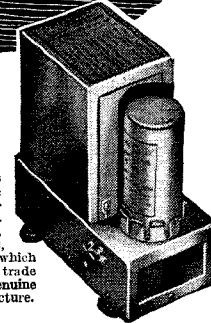

\* Vibrapack is a registered trade mark the property of the P. R. Mallory & Co. Inc., Indianapolis, U.S.A. Units which do not bear this trade mark are not of genuine Mallory manufacture.

We can give you prompt service and shipment.

Model	Input	Output
VP.551 Self-Rectifying	6.3 V.	125-150-175-200 V.
VP.552 "	6.3 V.	225-250-275-300 V.
VP.553 Valve	6.3 V.	125-150-175-200 V.
VP.554 "	6.3 V.	225-250-275-300 V.
*VP-G.556 Self	12.6 V.	225-250-275-300 V.

\* Especially designed for aircraft, boat and auto service.

**P. R. MALLORY & CO. INC.**  
INDIANAPOLIS INDIANA U.S.A.

Represented exclusively in Gt. Britain by  
**FRANK HEAVER LTD.** Kingsley Rd. Bideford N. Devon Eng.



**AT YOUR SERVICE**

**AMBASSADOR RECEIVERS** for HOME, CIVIL TRADE EXPORT AND THE FORCES

**CONTRACT WORK** for CABINETS, COILS I.F. TRANSFORMERS MAINS TRANSFORMERS CHOKES, etc., etc.

SEND US YOUR ENQUIRIES

**R. N. FITTON LIMITED**  
HUTCHINSON LANE • BRIGHOUSE • YORKS  
Phone: Brighouse 283

**M-R SUPPLIES**

offer from stock the following **FIRST-CLASS BARGAINS** in RADIO and ELECTRO-TECHNICAL EQUIPMENT. Satisfaction assured.

**G.E.C. MODEL 1575 MICROPHONES.** The celebrated Bronze Transverse Current type (pre-war list £7/10/-), offered, brand new, at 52/6. Also a few MODEL 1574 LABEL MICROPHONES (about 1 1/2 ins. sq.), complete with cord and connector (pre-war list £4/5/-) 39/6. To-day's finest make bargains.

**PRELIMINARY AMPLIFIERS** for photo-cell. Readily adapted for microphone. Without valves require 1 H.F. Pen. and 1 Det.). Require external H.T. and L.T. Fully smoothed and decoupled. Size 5in. by 2 1/2in. by 6 1/2in. high, 15/-.

**PHOTO-ELECTRIC CELLS.** Several large cinema interests took advantage of our last month's announcement. Still a few left of brand new **CETRON** model 5WB-C, size only 2 1/2in. by 1 1/2in. Suitable for most sub-standard cines and for all light control. Sensitivity 100/400 microamps per lumen. (Similar cells often charged at £5 and over), great opportunity, 29/6. Also last few of the **CETRON** C.E.1 model, with standard UX cap, 39/6.

**WESTERN ELECTRIC RESISTORS** 6-watt rating in following values only—6,500, 8,500, 10,000, 13,050, 15,000 20,000, 40,000 and 50,000 ohms. Wire wound, sheath protected. 1/- each or 10/6 dozen.

**MERCURY SWITCHES.** Single-pole change over, breaking up to 10-amps. Bead-insulated leads at bottom of tube which is 1 1/2in. long, 4/6.

**ELECTRO-MAGNETIC COUNTERS.** Coil res. 3 ohms or 500 ohms, counting up to 9999. Many domestic and industrial applications, 5/6. Dozen lots 4/10 each.

**PUBLIC ELECTRIC CLOCK MOVEMENTS.** Special heavy duty models fitted with auxiliary motor for remotely starting and re-setting clock. First-class instrument finish. 200/250 v. 50 c. Model A, for clocks up to 4ft. diameter, 49/6. Model B, for clocks up to 6ft. diameter, with set of bushes for hands, 59/6. Suitable e/over switches, 2/6.

**ROTHERMEL-BRUSH D.104 PIEZO-CRYSTAL MICROPHONE INSETS.** As used in the famous 5-guinea D.104 Microphone, only requiring housing. Can be used exactly as supplied. For P.A., deaf-aid, etc. 25/-.

**BRUSH PIEZO-CRYSTAL ELEMENTS.** 2 1/2in. dia., fitted stylus. Very popular offer for construction of microphone, cardiophone, piano-repeater, vibration detector and other domestic and industrial purposes, 6/11.

**GEARED HIGH-TORQUE MOTORS.** Operation 15/30 v. A.C. Final spindle speed 60 r.p.m. Reversible, with auto 2-pole make switch. Made for radio tuning but useful for many other purposes—recording instruments, contact making, drawing cine curtains, etc., 6/6. Also 200/250 v. A.C. model, final speed 3 or 6 r.p.m. (two models) extremely high torque. Synchronous and precision made, 25/-.

**LOW TENSION RECTIFIERS.** Permanent metal type by famous British maker. D.C. delivery, 12/14 v. 1.5 amp., 10/9. Also Heavy Duty Model, D.C. delivery, 12/14 v. 5 to 6 amps. 33/6. (See below).

**STEP-DOWN MAINS TRANSFORMERS.** To suit above rectifiers and for low voltage shalter lighting, models, etc. All prices 200/250 v. Sec. 7/11/15 v. 2 amp., 11/6. Sec. 22 v. 2 amp., 13/3 (ideal for Tuning Motors above). Also new Heavy Duty model, for use with 33/6 rectifier, tapped for 6 and 12 v., charging at 5 amps., 35/- Unbeatable values in high-grade charging equipment.

**BED-SWITCH CONVERSION SETS.** Comprising 2-way conversion tumbler switch (which takes the place of the ordinary wall switch) 2-way pear switch, 15ft. 3-way silk-covered flex, etc., Very easily installed—instructions sent. (Pre-war list 7/6), 4/11. Or 4/- per set in dozen lots.

**MINIATURE P.M. MOVING COIL UNITS.** Only 5in. dia. For use either mike or speaker and exactly right for all intercom. systems—12-ohms imp. High-flux alni magnet. Very well made, 13/6. Suitable G.E.C. Transformers, 3/9.

**L.T. SMOOTHING CHOKES, 4/6. L.T. SMOOTHING CONDENSERS (T.C.C.)** 1,000 mf. 12 v., 3/9. **B.I. RESIN CORED SOLDER** (50 p.c. tin), 18ft., 2/6.

**ROTHERMEL PIEZO-CRYSTAL PICKUPS,** Standard model, with arm, 37/6.

In stock: **ROTARY CONVERTERS, SLIDING RHEOSTATS, ELECTRIC CLOCKS, BATTERY CHARGERS, ELECTRIC MOTORS,** etc. Latest list sent with each order.

**M-R SUPPLIES, 68, New Oxford St., London, W.C.1**  
Telephone: MUSEum 2958

# ELECTRADIX RADIOS

### DYNAMO BARGAINS

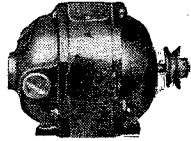

110-volts, 8 amp. D.C. ball bearing, semi-enclosed, 1,850 revs., 15lb. 6in. x 5in., cheap. Carriage paid. **15/6**

DYNAMOS.—Double Current, Govt., cost £15. Two commutators, D.C., 6/8s., 3/5 amps. and H.T. 400/600 v., 100 mm, 5 1/2 in. dia., 12in. long. 17 lbs., 4,000 revs., ball bearings, 25/-.

We have some surplus solenoids, 45/-.

**SMALL A.C. MAINS MOTORS.**—Enclosed, self-start on load. 230 v., 1/80 h.p., Type 40, 1,500 revs., 13/6. Split phase, 1/10 h.p., 2,500 revs., 45/-.

**SMALL D.C. MAINS MOTORS.**—1/40 h.p., Type 60, 220 v., K.B. series, 1,750 revs., 15/-.

Ditto, 1/40 h.p., G.E.C., 230 v. series, 2,000 revs., 16/-.

Ditto, 1/12 h.p., Croynon 110 and 230 v. shunt, 1,700 revs., 30/-.

M.G. for A.C., 220 v. to 100 v., 1 amp., D.C., 7/43, 100 v., 15/-.

All fully guaranteed.

**MOTOR DRIVES.**—Morse 1 h.p. Silent Chains, new, 29in. long, with large and small 1 1/2in. sprockets, ratio 4 to 1, for motor drive, projector, 8/6.

**GEARS.**—Skew drive Gear Boxes for Cine. or Boat. 1 or 2 h.p., 10/-.

Ditto on C.I. Pedestal, with flywheel, 15/-.

Small 3 to 1 Gear Boxes, 4/6.

**DRILL STANDS.**—Massive machined steel drill stands, Wolf type, with rise and fall handle and counter weight, height 32in., weight 102 lb. Sale price 10/-.

Car. forward.

**ELECTRIC GOVERNORS.**—Centrifugal control, 1,500 r.p.m. contacts, brushes, slip rings for autosped regulation, 7/6.

**D.C. GENERATORS.**—120 watt, 12/16 volts 30 amps, with v. pulley, 45/-.

Shunt wound—110 volts, 4 amp., 10 lbs., 10/6; 110 volts 1 amp., 15/-; 200 volts 1/2 amp., 17/6; 200 volts 1/4 amp., 26/-.

**WINDMILL GENERATORS.**—totally enclosed, ball-bearing, start charging at 300 revs., 6 to 12 volt., 8 amps., 75/-.

**D.C. MAINS MOTOR GENERATORS.**—D.C./D.C., 220 v. to 30 v., 10 amps., 57/10/-.

M.G. Crompton, D.C./D.C., 100 volts to 17 volts 6 amps., 24/7/6, 200 v. to 16 v., 5 amps., 25/-.

Estro M.G. ditto to 6 volts 4 amp., 45/-.

Motor generators for all outputs up to 60 amps.

### ALTERNATORS

**1-PH. PHASE HIGH CYCLES TEST ALTERNATORS.**—The famous 52a WATERFORD H.F. Alternators 250 watts at 500 cycles, 20 volts 10 amps. Self exciting inductor type, stout wound stator. Small size. Cost £30. Sale, 70/-.

**WOO-LWICH** 400 watt 46/W/A 500 cycles 50 volts 3 amps. and D.C. of 70 volts 3 amps., 25/10/-.

**S.M.D. Co.** 500 watts 300 cycles 200 volts, high speed, 43.

**MOTOR-ALTERNATORS.**—170 cycles, Marconi type, 1/2 kW. and 3/4 kW. Motor of 100 volts D.C., £10, 2/1 kW. NEWTON Vertical, 580 cycles 200 volts 25 amps., 1,600 revs. Motors, 220 volts D.C., 42/0.

**3-PHASE ALTERNATORS.**—G.E.C. 333 cycles 3 ph. 150 volts 1 amp., fitted reed Tachometer. Self exciting horizontal, 96/10/-.

**A.C. HAND ALTERNATOR.**—Permanent steel magnets, wound armature driven by gearing and handle. Output of 80 volts 200 ma. A.C. For Medical Treatment. A.C. experiments, etc. Sale, 7/6. Carriage, 1/-.

### ENGINE SETS

Horizontal Twin Petrol A.B.C. Engine fan-cooled, coupled 1 1/2 kW. D.C. Dynamo 50/70 volts 25 amps., Mag. Ignition. Cost £190. Sale, £25.

2 1/2 kW. AUSTIN, 2 Cyl. water-cooled Engine. Mag. Ignition and 110 volts 25 amp. Dynamo, £26.

Austin 3 1/2 kW. 110 volts, £48. Switchboards, 25. Ask for Special Leaflets.

**1, 2, and 2 1/2 H.P. ENGINES IN STOCK.**

**A.C. ROTARY CHARGERS.**—3-phase Motor 200 volts, Dynamo 8 volts 15 amps., D.C., 24/17/6. R.C.A. 3 ph. Motor 220 volts, 600 volts, 200 m.a., D.C., 25/10/-.

230 volts A.C. Motor D.C. Dynamo 18 volts 11 amps., D.C., 26/17/6.

**300 CELL A.C./D.C. CRYPTO MOTOR-GEN. SET.**—220 v. A.C. For Radio Cells and ten 12-volt 10 amp. Car. Batts. D.C. output 160 volts 20 amps. Sale, £32.

**CRYPTO** Constant Potential Rotary Charger. Single Phase Motor. D.C. output 8 volts 50 amps. L.T. and 100 volt 1 amp. With switchboard, £30.

**A.C. ROTARY CHARGER.**—3 h.p. 220 volt D.C. Motor 6 volt 250 amp. Dynamo, £16. 200 volt Motor 25 volts 3 amps, flexible, £4. Motor 220 volts 8 amps. dynamo, 26/10/-.

And others.



### SPEAKERS

**MAINS ENERGISED SPEAKERS.**—6in. 1,200 ohms, with speech transformer, 7/6. Magnavox, 6in. type, 12/6.

**M.C. SPEAKERS.**—7in. cone and transformer, 25/-; 8in. cone with transformer, 27/6.

**BATTERY ENERGISED SPEAKERS.**—K.B., 6 volt, 8in. cone, 8/6.

**P.A. HORN SPEAKERS.**—Emerson Tone Correct Horn and Slings, as illus. New Perm. Mag. M.C., 15 watts without distortion, 24in. Flare, 40in. long, 26/8/-.

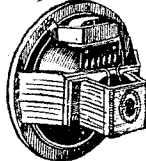

**TANNOY AND MARGONIPHONE.**—P.M. Short Horn Model P.A., 12-15 watts, as new, 36in. High Power P.M. Speakers with Aluminium Horn for van top; handles 30/40 watts, 22.

**MAINS P.A. AMPLIFIERS.**—For pure sound amplification and Recording. Complete and cased, not naked chassis. Special Bargain, professional portable 5-6 watt Amplifier, A.C. or D.C. in covered cabinet with handle, 20 lb. weight only. Ideal for singer, entertainer or grammo, only 23. Small pre-amplifier, Philips 2-watt A.C. mains, in steel case, only 24/10/-.

10-watt steel case Amplifier, quite new 28/15/-.

All these are complete with valves ready for use. Set by Ardente, fine job, 20 watts pure output, A.C. mains, 21/6. Complete with valves.

### SHEFFIELD MAGNETS FOR MOVING COIL SPEAKERS.

**Powerful New Steel. Four-claw 4 1/2 lbs. 10 watt M.C. Speaker. Permanent Magnets at manufacturers' price. A great opportunity for 5/-**

**250 NEON LAMPS.**—Standard size letter neon bulb with holder, 220/240 v., 2/6.

**Medical Shock Coils, 5/6 and 7/6. 300 Ignition Coils, 6 or 12 volts, 3/6.**

**DIAL TUNING.**—10-point Finger Switch Dials, as illus., used on G.P.O. Automatic Telephones. These have spring drive, governor, clutch and contacts inside. Price 2/6.

**TELEPHONES** for all purposes. House, Office, Garage and Field Sports. Wall type, as illustrated. Table models cheap. Send for lists.

**HEADPHONES.**—2,000 ohms, 5/6. Single high res. earpieces, 2/6.

Sullivan 120 ohm W.D. model, Aluminium body and headbands. Maker's price to-day, 15/-.

Our price, 4/9 per pair, cords extra. 6d. postage. Pocket Headphones, all leather and cords, 4/6 pair.

**TALKIE SOUNDHEADS.**—Brown's Universal, less optical, independent driven, soundhead flex shaft, head amplifier, lamp and P.C. Sale 28. Soundhead Brown's Standard with head amplifier, new, fits most projectors, £10. Cost £17/0.

Cinephone Soundhead with P.C. and meter, 27. B.T.P. Soundhead with Osram P.C., new condition. Beck optical, 28/10/-.

Mihaly Soundhead, 28/10/-.

**SOLO VARIABLE AIR CONDENSERS** for Wavemeters and Single Circuit Tuning, logarithmic blades, .0005 mid., new. Type F, 2/6.

**TEKADE**, bakelite dielectric Tuning or Reaction variable condenser, .0005 mid., 1/6.

**CAMERASCOPIES** True-Twin, 2 lens viewers, folds flat, 1/3.

**CHARGE METERS.**—Weston Model 354. Central zero 1 to 15 amps. D.C., pol. mag. dead beat. Flush panel, 2 1/2 in. dial. Sale price, 9/6.

**NEW PANELS.**—Paraloxin or Ebonite. Ebonite quarter-inch Panels, 24in. x 24in. for 8/6, Carr. Fwd.

**ALUMINIUM FOIL**, 12in. by 12in., .9d. sheet.

**SCREENALL** for lining Cabinets, anti-interference screen, flexible, fireproof thin asbestos faced aluminium foil back and front. Any length cut in 24in. width, 1/- per 2 square feet.

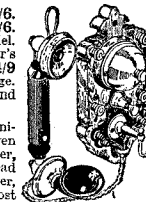
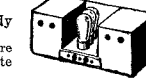

### The ROLLS-ROYCE of BUZZERS is the CAMBRIDGE-TOWNSEND TINY AND SHRILL

Perfect for Wavemeters, ideal for signals. High note model "T" Diaphragm blade. Platinum Contacts. The smallest Buzzer possible. **10/-**



### MERCURY SWITCHES

SWITCHES operate 5 or 10 amps. 250 volts, from a pocket cell indefinitely, hermetically sealed and absolutely gas tight, 30/-.

**SWITCHES.**—Aerial-Earth D.P.C.O., 3/6. Stud Box Switch, 8-way on panel by R.I., for meter ranges, etc., 7/6. Larger type G.P., with 10-way studs, 5/3.

**VALVE & REK WAVECHANGE D.P.**, 3-way roll contact, 1/3. Bulgin 3-point wavechange, 2d. Tuzewell S.P. on-off, 8d. 20-way panel Stud Switches, contact arms and ring for fitting 300-ohm 1 amp., 20-amp resistance, 10/6. 7-way Stud Switches on 2 1/2 in. panel, with plug sockets, 1/9. 10-way D.P. ebonite, mounted, 8 amps., 5/6. 12-way D.P., 5 amps., 4/-.

G.E.C., 10 amp. D.P. linked, 3/-.

**SUPERSENSITIVE MOVING COIL RELAYS.**—These work on really tiny currents from photo-cells, etc., and a small rectifier can be used for A.C. For panel use, the small 2in. flush Lesdix meter type W1 works on 50 micro amps. Handles 150 mills, on main contact, 55/-.

**A 2 m.a. TABLE RELAY** for radio work. Compact vertical type, enclosed. Single 3,000 ohm coils. Platinum contacts. Screened polo change-over, 1 amp. contacts. Wood base. Metal case. Size 2 1/2 in. diam., 3 1/2 in. high. Price only 8/-.

G.P.O. glass top B. Relays are twice the size, massive platinum contacts, 15/-.

Some chipped, 10/-.

A few hundreds, 5/-, 6d. postage. 10 other models of relays in stock. Send stamp for illustrated leaflet.

**UNUSED X-RAY VACUUM TUBES.**—New Government Hospital Surplus. 7in. dia. bulb. Big solid Tungsten Electrodes. Emission guaranteed. COST 25. SALE, 15/-.

Callers only. **LIGHT AND RAY CELLS.**—Electrode, self-generating, 25/-.

Photo-cells for sound on Film and Ray work, I.C.A., 55/-.

Beck, Angle Prisms, mounted in carrier, 5/6.

**THERMOMETERS.**—Panel 2 1/2 in. dial, 5ft. ether tube for distant indicating, reading 0 to 100 deg. Cent, 7/6.

**FOURNIER THERMOMETERS** by Cambridge Instrument Co., 4in. dial, 10-110 deg. Cent. Fitted adjustable electric contacts, 45/-.

12in. right angle Immersion Thermom. to 100 Cent., 28/-.

**HOME RECORDERS.**—Electrical Home Recording require: Tracking Gear for Grooving, Traverser, etc., 25/-.

**CUTTER** needles, sapphire, 3/6. Real Diamond, 7/6. Rotary Needle Sharpeners, 1/6. Wood Needles, round or triangle, 1/- doz.

**SMALL RHEOS.**—Back of panel, one hole, front knob; Rotary Igranio 10 watts, 4 ohms, 2 1/2 amps., 2/6; 6 ohms, 1.7 amps., 2/6; 10 ohms, 1 amp., 2/-; 20 ohms, 1/2 amp., 2/-; 30 ohms, 3 amp., 1/3; 30,000 ohms Reg. Volume Controls for Gramos or Mikos. Resistors, on mica, 8 ohms, 1 1/2 amps., 9d.

**POTENTIOMETERS**, Igranio Indigraph 300 ohms, list 5/-, sale 1/-.

30,000 ohms, 1/6. Combined high and low rheos, 2/-.

### TEST GEAR

**ELLIOTT BATTERY LOAD TESTERS.**—Government Model 103. Moving Coil Ammeter and graded resistor, 37/6.

230 Volts A.C. 2 1/2 kW. RECTIFIER EQUIPMENT, with 5 kW. transformer and Philips valve, D.C. output, 230 volts 10 amps., £15.

**TEST PANEL**, with 4 meters for full-range works testing. Ranges 5 m.a. to 12 amps. D.C. or A.C., with rectifier and transformer, 5 volts to 500 volts, 7in. dial meter on steel panel, 27in. x 30in., £12.

**4-RANGE A.C. WORKS AMMETER**, by Elliott, for 5, 25, 100 and 400 amps., with selector switch, 26/10/-.

**CELL TESTERS.**—Megger 3-0-3 moving coil. Aluminium bodies, 12/6.

**DISTRIBUTION BOARDS.**—Polished Hardwood, glass door, clip fuses. D.P., four of 12-way, one 8-way, two 6-way, six 5-way: all at 2/- per way.

**HOT WIRE METERS** for Radio or Low-Frequency. 1/2 amp., 2 1/2 in. dial, front panel, 100 m/a. to 1/2 amp., 10/-.

200 m/a. to 1 1/2 amp., 7/6. 500 m/a. to 2 amps., 7/6. To 2 1/2 amps., 15/-.

High voltage model in square ebonite case, 13 amps., 10/-.

Special Sullivan Meters with cut-out switch, 15/-.

Grade magnet damped H.W. Meters, 100 to 500 m/a., 4in. dial, Marconi type, 25/-.

200 m/a. to 1 1/2 amps., J. & P., brass case, 27/6. 2 amp. and 3 amp. ditto, 32/6. 6in. and 8in. H.W. meters to 10 amps., 20 amps. and 50 amps., 40/-.

**METER MOVEMENTS.**—Full size, moving coil, P.M. for adapting home-made multi-range testers. For 3in. or 4in. dials, 6/- Post 1/-.

# ELECTRADIX RADIOS WE ARE STILL AT 218, UPPER THAMES ST., LONDON, E.C.4. Telephone: Central 4611

THE CHARGE for advertisements in these columns is: 12 words or less, 3/-, and 3d. for every additional word. Each paragraph is charged separately. Series discounts are allowed to Trade Advertisers; particulars on application.

ADVERTISEMENTS for the May issue are accepted up to First Post on Tuesday, April 8, at the Head Offices of "THE WIRELESS WORLD," Dorset House, Stamford Street, London, S.E.1, or one day earlier at provincial Offices.

THE PROPRIETORS retain the right to refuse or withdraw advertisements at their discretion. They are not responsible for clerical or printers' errors, although every care is taken to avoid mistakes.

CHEQUES and POSTAL ORDERS should be made payable to LILFE & SONS LTD., and crossed.

NOTES are legal tender and cannot be traced if lost in transit. They must therefore be regarded as being despatched at sender's risk. Alternatively, they may be sent per registered post.

FOR THE convenience of private advertisers, letters, other than circulars, etc., may be addressed to numbers at "THE WIRELESS WORLD" Office. When this is desired, the sum of 1/- to defray the cost of registration and to cover postage on replies, must be added to the advertisement charge, which must include the words:

## Wireless World CLASSIFIED ADVERTISEMENTS

Box 000, c/o "The Wireless World." All replies should be addressed No. 000, c/o "THE WIRELESS WORLD," Dorset House, Stamford Street, London, S.E.1.

READERS WHO reply to Box Number advertisements are warned against sending remittances through the post except in registered envelopes. In all such cases the use of the "Deposit System" is recommended, and the envelope should be clearly marked "Deposit Department."

DEPOSIT SYSTEM.—Readers who hesitate to send money to advertisers in these columns may deal in perfect safety by availing themselves of our Deposit System. If the money be deposited with "THE WIRELESS WORLD," both parties are advised of its receipt. Notes and Money Orders save time. Cheques should be made payable to Lilfe & Sons Ltd., and are acknowledged to seller when "cleared." The time allowed for decision is three days, counting from receipt of goods, after which period, if buyer decides not to retain goods, they must be returned to sender. If a sale is effected, buyer instructs us to remit amount to seller, but if not seller instructs us to return amount to depositor. Carriage is paid by the buyer, but in the event of no sale, and subject to there being no different arrangement between buyer and seller, each pays carriage one way. The seller takes the risk of loss or damage in transit, for which we take no responsibility. Details of any arrangement made between parties which does not concur with any of the above conditions must be advised to us when the deposit is made. For all transactions, whether a sale is effected or not, a commission of 1 per cent. is charged on and deducted from the amount deposited (minimum charge 2/-). All deposit matters are dealt with by Lilfe & Sons Ltd., Dorset House, Stamford Street, S.E.1.

# ARMSTRONG —WANTED—

Owing to Government requirements various components necessary for servicing Radio receivers are becoming more difficult to obtain and as we are anxious not to disappoint users of our chassis, we are making an appeal to our old customers, who, through joining the Services or for any other reason have an Armstrong chassis for disposal, to get into communication with us, when we shall be pleased to make a fair cash offer for same.

The Models particularly required are AW125PP, SS10, AW93PP, 3NBP/T, 3NWT, AW38, AW59/T, RF73, RF94, AW104PP, AW3PB, 3WT/PB. These models vary in age up to 4 years, but a few older chassis will be considered. It is not necessary for them to be in working order but it is essential for the majority of the mechanical parts to be in good order, so that they can be made use of for service work.

Any owner of a chassis who takes advantage of this offer will be helping other users of Armstrong chassis and at the same time obtaining a better purchase price than would normally be expected for a second-hand radio receiver. Please send particulars of the chassis for disposal together with the Guarantee or invoice number if available, and we will advise you of its present cash value.

**ARMSTRONG CO.**  
Service Department can make any Armstrong chassis, irrespective of age, a thoroughly reliable instrument and restore its original performance. We have been asked by many "Wireless World" readers to service chassis not of our manufacture and we have now decided, whilst we still have skilled Engineers available to undertake this work.

**ARMSTRONG CO.**  
have a limited number of high quality speakers at very economical prices, for example:—  
11in. Heavy duty M.C. speaker, capable of handling a large output if so desired, fitted with free moving cone and very heavy field. D.C. resistance of field 800-1,000 ohms. Voice coil impedance 7 ohms. Price £3 3s. 0d

We recommend these speakers as particularly suitable for working with any of our Radio chassis and audio frequency amplifiers designed to give high quality output.

Armstrong Co. have various other speakers available at economical prices. Kindly send your requirements.

**ARMSTRONG MANUFACTURING CO.**  
WALTERS ROAD, HOLLOWAY, LONDON, N.7.  
Phone: NORth 8213.

## NEW RECEIVERS AND AMPLIFIERS

LIMITED Number of Wireless World Push-pull Quality Amplifiers Available. Amplifiers with larger outputs and 12-volt battery models to special order.—Camborne Radio Co., Trelowarren St., Camborne, Cornwall. [9487]

£15/10 Only, usual price £22.—Wireless World 2 R.F. Receiver with push-pull quality amplifier, 10 valves, including tone control stage, 8 watts triode output, ideal for quality reproduction from radio and gramophone; limited number.—Bakers Selhurst Radio, 75, Sussex Rd., South Croydon. [9422]

## RECEIVERS AND AMPLIFIERS SECOND-HAND, CLEARANCE, SURPLUS, ETC.

HEIGHTMAN'S U.H.F. Receiver, valves and coils 5 to 40, carefully constructed; £12/10.—Lownds, Baking, Notts. [9468]

NATIONAL N.C.44 Communication Receiver, 7-valve, 4-waveband, 10-500 metres, with speaker, new; sacrifice, £15.—May, 11, Reepham Rd., Norwich, Norfolk. [9469]

W.W. Pre-tuned Quality Receiver Only, 230v. A.C. induction gramophone motor, tone-arm for E.M.G. head, Goodman's Auditorium speaker.—Box 2569, c/o The Wireless World. [9480]

4-WATT Amplifier, P×4 output, valves, 10in. speaker, complete, 75/-; 7-watt Amplifier, 5 valves, push-pull multi ratio output, £7; 15-watt, ditto, £8; Magnavox 35 duode speaker, £3; AC gram. motor; s.a.e. details.—101, The Avenue, Pinner. [9492]

### Wanted

NATIONAL 80X for D.C. Mains, details.—Finn, "Rafcen," Wash-on-Dearne, Rotherham. [9477]

ARMSTRONG S.S.10 Chassis, perfect; reasonable price.—Details to 49, Burniston Rd., Hull. [9484]

SKY Biddy or Champion, reasonable condition.—S. Abbott (G3JU), "Y-Worry," Banbury Rd., Bicester. [9489]

COMMUNICATION Receiver, must be good for make for cash.—Green, 3, Hobmoor Rd., Birmingham, 10. [9486]

WANTED for Cash, communication receiver.—Price and details to Reed, 58, Arbutus Drive, Coombe Dingle, Bristol. [9472]

WANTED.—W.W., Scott or McMurdo chassis, 8 watts or over, all waves; price, etc.—22, Pendine St., Chetcham, Manchester. [9490]

## NEW MAINS EQUIPMENT

VORTEXION Mains Transformers, chokes, etc., are supplied to G.P.O., B.B.C., L.P.T.B.; why not you?

WE are Compelled Through Rising Costs to Increase our Prices by 10%.

VORTEXION, Ltd., 257, The Broadway, Wimbledon, London, S.W.19. Phone: Lib. 2814. [9233]

## NEW LOUD-SPEAKERS

BAKERS Brand New Surplus Speaker Bargains.

EVERY Music Lover Interested in Realistic Reproduction should write for free descriptive leaflet now.

£5/10; usual price £10.—Brand new permanent magnet infinite baffle speaker, complete with beautifully finished cabinet in polished walnut.

£2/10; usual price £5.—Brand new super quality triple cone speaker, permanent magnet model; exceptional bargain; limited number. SECURE One of These Exceptional Bargains Now.

BAKERS Triple Cone Conversions Will Immensely Improve Reproduction of Your Present Speaker. ("For a few shillings you have converted a speaker scheduled for the scrap heap into one worth pounds.—W. E. Darby, Grad.I.E.E.") Write for details.

BAKERS SELHURST RADIO, 75, Sussex Rd., Sth. Croydon. [9423]

CELESTION, Model "55," 2,500 ohms, energised, brand new, boxed, 50/-; Benjamin A.C. Kit, £1, boxed.—Rodmell, 25, Ormonde Av., Hull. [9463]

## PUBLIC ADDRESS

VORTEXION P.A. Equipment.

LIMITATED, but unequalled.

WE Invite You to a Demonstration.

A.C.-20 15-20-watt Amplifier, 38-18,000 cycles, independent mike and gram., inputs and controls, 0.037 volts required to full load, output for 4, 7.5, and 15 ohms speakers, or to specification, inaudible hum level, ready for use; 8½ gns. complete.

C.P. 20 12-volt Battery and A.C. Mains Model, as used by R.A.F., output as above; 12 gns.

A.C. 20, in portable case, with Collard motor, Piezo pick-up, etc., £14; C.P.20 ditto, £17/17.

50-WATT Output 6L6s, under 60 watt conditions, with negative feedback, separate rectifiers for anode screen and bias, with better than 4% regulation level response, 20-25,000 cycles, excellent driver, driver transformer, and output transformer matching 2-30 ohms impedance electronic mixing for mike and pick-up, with tone control, complete with valve and plugs; £17/10.

COMPLETE in Case, with turntable, B.T.H. Piezo pick-up and shielded microphone transformer; £22/10.

80-WATT Model, with negative feedback; £25, complete.

120-WATT Model, with negative feedback; £40, complete.

250-VOLT 250 m.a. Full Wave Speaker, field supply unit 25/-, with valve.

WE are Compelled Through Rising Costs to Increase our Prices by 10%.

ALL P.A. Accessories in Stock; trade supplied.

SEE Our Display Advertisement on page 119 (Edit.).

VORTEXION, Ltd., 257, The Broadway, Wimbledon, S.W.19. Phone: Lib. 2814. [9232]

## SHORT-WAVE EQUIPMENT

GENI for Short Wave Equipment; largest stocks in the country; communication receivers; National agents; American and British Valves, etc. See advertisement on page 2-44, Holloway Head, Birmingham. [0531]

"H.A.C." Short-wave Receivers, famous for over eight years; latest model one-valve now available; complete kit of precision components, accessories, full instructions, requiring no soldering; only 12/-, postage 6d.; illustrated catalogue free.—A. L. Bacchus, 109, Hartington Rd., S.W.8. [9476]

## CABINETS

A CABINET for Every Radio Purpose.

SURPLUS Cabinets (Undrilled) from Noted Make.

WE Have Hundreds in Stock (no Catalogues); send measurements of chassis, etc., and say what kind of cabinet required; stamp for reply.

INSPECTION Invited.

H. L. SMITH and Co., Ltd., 289, Edgware Rd., W.2. Tel.: Pad. 5891. [9331]

## DYNAMOS, MOTORS, ETC.

ALL Types of Rotary Converters, electric motors, battery chargers, petrol-electric generator sets, etc., in stock, new and second-hand.

WARD, 46, Farringdon St., London, E.C.4. Tel.: Holborn 9703. [0518]

FOR Sale, second-hand, in first-class condition, Rotary Converter, input 230 volts, output 400 volts at 1.7 amps; also receiving set relay to 220 loudspeakers.—Secretary, Haig Homes, Green Lanes, Morden, Surrey. [9461]

### Wanted

ROTARY Converters, 220-230 volt D.C. to A.C., record changers, large moving coil speaker units, mains transformers, transformer cores (burnt out), amplifiers, etc.—W. T. Rickards, 22, Salter Rd., Summerhill, Tipton. [9452]

## WARD

**WE MANUFACTURE:**

ROTARY CONVERTERS  
DC/AC for operating P.A. amplifiers, Radio Receivers, etc.

DC/DC ROTARY TRANSFORMERS, SMALL ALTERNATORS, SMALL DC MOTORS, H.T. GENERATORS, MAINS TRANSFORMERS up to 10 k.v.a. PETROL ELECTRIC generator sets up to 50 k.v.a.

BATTERY CHARGERS for private and industrial use.

We can also handle general small engineering work.

Full details of any of the above upon request

**CHAS. F. WARD**  
46, FARRINGDON ST., LONDON, E.C.4  
Telephone: Holborn 9703.  
Works:  
37, White Post Lane, Hackney Wick, E.9.

# Ode Partridge

No. 6

## SPRING

Nature stirs from winter's sleep,  
Stretches her arms,  
The young shoots peep  
Above the ground.  
'Tis Spring!

Latent life bursts forth anew,  
Drabness departs,  
Earth's greenish hue  
Delights our hearts  
In Spring.

So we thought in days of Peace,  
And in those times  
Nought could increase  
Our gratitude  
For Spring.

Shall we change our happy mood  
Because of threats  
So dire, and brood  
Or look with fear  
To Spring?

Rather should we lift our eyes  
In thankfulness,  
For nothing dies,  
But dormant rests  
Till Spring.

Courage, strength, and skill are ours  
To overcome  
The evil powers,  
And so they will—  
This Spring.  
Then the Star of Right will rise,  
Force and Terror  
Will recognise  
Their fate is sealed—  
Next Spring.

In April, 1911, the first issue of "The Wireless World" appeared under its original title "The Marconigraph." Our heartiest congratulations on its 30th anniversary.

# N. Partridge

B.Sc., A.M.I.E.E.

King's Bldgs., Dean Stanley St.,  
LONDON S.W.1

Telephone VICTORIA 5035.

# TRIX SOUND EQUIPMENT

RELIABLE AMPLIFICATION  
THE TRIX ELECTRICAL COMPANY LTD.  
65, Bolsover St., London, W.1. Euston 5471

## FOR SHORT-WAVE COMPONENTS

Communication Receivers for work of National importance; and all accessories for short-wave work and experiments. Call or write to

### WEBB'S RADIO

14 SOHO ST., OXFORD ST., LONDON, W.1

## COMPONENTS

### SECOND-HAND, CLEARANCE, SURPLUS, ETC

G. A. RYALL, "Arnehurst," Marsh Lane, Taplow, Bucks (late Ryalls Radio of London), offers radio goods, all new, unless otherwise stated. Post free.

**AMPLIFIER Chassis Complete**, ex the Pathoscope cine outfit, contains the two mains transformers as below, two Hunts 8 ml, 500v. Mansbridge 2x1 ml, pair low voltage cathode condensers, group board with resistances as below, toggle switch, P.C.C. 0.01, two Erie resistances, 5-pin socket for speaker, fully wired, with mains leads and double adaptor, flat pancake-type chassis (SG as LF valve, pentode output, rectifier), gramophone input socket, three valve holders, less valves; 18/6 the lot, carriage paid; chassis may be had without speaker if desired. See below.

**MAINS Transformers**, made by Standard Telephones for Pathe amplifier, input 110-250v. A.C., outputs 350-0-350v. 120 ma., 4v. 2 1/2 amp., 4v. 4-5a., special heavy primary, used as 250w. Auto trans. for other items below; can be used as 300w. auto transformer, drop through type, size 5 1/4 x 4 3/8 x 2 1/2 in. deep; 10/9 each, used, as new.

**A.C. Induction Motors**, fitted with fan cooling, 1.500 revs, one-tenth horse power, 110v. for use with above transformer, supplied 8 ml. paper block condenser, as used motors, fitted 4-pin plug; 14/9, used, as new.

**A.C. Transformer**, input 110v., for use with above transformer, secondaries 10v. and 20v. at 5 amps and 8 amps; 4/9.

**ROLA 10in.**, 2,000 ohm Energised Speakers, pentode transformers, with over 11 yards 3-way cable with 5-pin plug, with 4 prong winder, in portable rexine carrying case, leather handle, brown finish, nickel plated corners. Note, speaker aperture is 8in. only, made for the Pathe cine outfit, and used with the Amplifier chassis, above, size 16 1/2 in. square, 7 1/2 in. deep, cases slightly soiled or marked, overall condition good, 15/9 each, complete. Not available apart from chassis above, 18/6.

**SPEAKERS** as above in Carrying Cases, less cable, S cases soiled or marked, fittings tarnished, speakers perfect, 10/9. Speakers only, 9/-.

**AMPLIFIER carrying cases**, slightly soiled or marked, 20x14x12, 4/9 each.

**BLOCKS** Containing Two Large Capacity Mansbridge Condensers, low voltage for cathode bypass, inverted chassis type; 1/6 each.

**AMERICAN Valves**, sets three, 2-volt American bases, 1A4 VM/HFP, 1B4 HFP, 2101 1/2-watt output Pentode; 6/6 the set of three; suit Philco sets.

**P.C.C. Units** on Small Paxolin Panel, comprise

**T.C.C. 0.01 mica condenser**, 0.15 non-inductive tubular, 2 meg. and 4 meg. 1/2-watt resistances; two for 1/6.

**CLIX Chassis Valve Holders**, 5-pin shield pattern and 7-pin lemon and circular; 2/3 dozen.

**KNOBS**—Small brown Ultra pattern, 1/3 dozen. Plug and socket 3-position, as used for mains input adjustment, 3 1/3. Large Goldtone HF mains chokes, heavy duty, two for 1/6; may be slightly soiled.

**DOUBLE Trimmers** on Paxolin ex GEC, single ditto, 2/- dozen. TMC 5 ml. Mansbridge type tubulars, three for 1/3. Ferranti wire wound resistances, nickel end caps, no holders, 4,000 and 35,000 ohms, four for 1/3.

**TWIN Rubber Cable**, heavy duty (001), suitable for vacuum, irons, etc., ideal for low extension Speaker leads, double vulcanised, in single container of tough rubber, 4/9 dozen yards, or 43/9 per 151 yards.

**SINGLE Rubber**, 19/36, various colours, about 1 1/2 mm., in 500 yard coils, 21/6 per coil. 250-yard coils push back connecting wire, 15/-.

**WELL-KNOWN Make 1-watt Resistances**, limited quantities sizes available 300, 400, 2,000, 3,500, 25,000 4,000, 1/2 meg., 1 meg., 2 meg., 2/6 dozen.

**MATT Speaker Cloth**, light colour, 36in. wide, cuts into nine 12in. squares, slightly soiled, takes lacquer paint well; 2/6 yard.

**G.E.C. "Tuneones" Tuning Indicators**, as used in the A.V.C. Five, 1/3 each. Slow motion (epi-cyclic) drives, fit 1/4in. shafts, long 1/4in. spindle, ratio 8-1, 1/3 each; well made in brass, with ball bearings.

**SATOR Midget Volume Controls**, less switch, 1 meg., 400,000 ohm., and 100,000 ohm., 1/3 each.

**PAXOLIN Strip**, 2 1/2in. wide, as used for group boards, etc., three 12in. lengths for 1/6.

**RESISTANCES**, 2-watt, well-known make, 7,500 and 9,000 ohm., three for 1/3; 370 ohm. 3-watt, two for 1/3.

**SPECIAL Note**—We are now confining our business to mail orders, and shall be glad to give prompt attention to a quiet situation.—G. A. Ryall, "Arnehurst," Marsh Lane, Taplow, Bucks. [9470

**VAUXHALL**—Rola 8in. P.M. speakers, with transformer, 14/9; 3-gang bandpass H.F. iron-cored tuning coils, 19/6; one-watt resistors, 4d.

**VAUXHALL**—Electrolytic condensers; 8 mid., 500v., 2/3; 8+8 mid., 500v., 3/9; mica condensers, 0.001 and 0.002 mfd., 4d.; paper tubulars, 0.25 mfd., 6d.; 0.001 mfd., 4d.

**VAUXHALL**—Cosmocond pick-ups, 11/- and 18/9; Niclet 3 1/2-1 L.F. transformers, 5/9; S.H. Ferranti A.F.6. 8/6.

**VAUXHALL UTILITIES**, 163a, Strand, London, W.C.2. Postage paid orders over 3/-. Send 1d. stamp for new valve list. [9453

**CONDENSERS**, electrolytic, metal cans, 8 ml. 450 v. volts working, 3/6; 8+8 ml., 450v. working, 5/-; 16 ml., 500v. working, 5/-.—Ruddock, Stonehouse Cottage, Penn, Bucks. [9491

# GALPINS

## ELECTRICAL STORES

Owing to War Conditions this business is now transferred to:—  
21, WILLIAM ST., SLOUGH, BUCKS.

Terms: Cash with Order

**ELECTRIC LIGHT CHECK METERS**, small, late type, well-known makers, in good condition, electrically guaranteed for 200/250 volts 50 cy. 1 phase A.C. mains. 5 amp. type, 6/-; 10 amp., 7/6; 20 amp., 9/- each. Post 1/- on all types.

**D.C. ELECTRIC LIGHT CHECK METERS**, 200/250 volts 5 and 10 amps., 4/6 each, post 1/- (in new condition).

**PHILIPS HIGH VOLTAGE CONDENSERS**. Infd. at 4,000 volt working, 5/6 each, carriage 1/6.

**REGULATORS, STARTERS AND LARGE DIMMER RESISTANCES**. Stud Switch-arm type. State wants. **SWITCHBOARD VOLT AND AMPMETERS MOVING COIL AND MOVING IRON**. All first-class makers. Please state requirements.

**EX R.A.F. GLASS ACCUMULATOR TANKS**, 5x5x8in., new and unused, 3/6 each, post 1/-.

**EX R.A.F. SWITCH PANEL**, with case (new), fitted 6 small knife switches, leads, cords and cleats, complete in wood case, 2/6 each, post 6d.

**SMALL ELECTRIC ROTARY CONVERTOR**, 110 volts D.C. input, 10 volts at 30 amps. output. Useful for garage charging, 55/-, carriage forward.

**HIGH-VOLTAGE TRANSFORMERS**, useful for all test work or television. Input 200/240 volts, output 5,000 and 7,000 volts, 7/6 each, post 1/-.

**VOLTAGE CHANGING TRANSFORMERS** (Auto Wound), 100/110 to 200/240 v., or vice versa, fully guaranteed, 1,000 watts, 60/-; 2,500 watts, 110/-.

**DUG-OUT LAMPS**, Ex R.A.F., solid brass construction, glass dome, complete with 12-volt bulb (any bulb can be fitted), wall fitting, 3/- each, post 6d.; Ditto, wing type, as new, 2/6, post 6d.

**DUG-OUT LAMPS**, Ex R.A.F., porthole type, or can be bracket fitted, glass dome, three colour fitting, white, red or green, solid brass construction, 6in. dia., complete with bulb; any size bulb can be fitted. Price 5/-, post 6d.

**1 kW. TRANSFORMER**, 100 v. input at 100 cycles, output 10,000 volts centre tapped, price 30/-, carriage forward.

**EX R.A.F. AUTOMATIC CHARGING CUT OUTS AND VOLTAGE REGULATORS**, to suit any dynamo up to 20 volts at 15 amps., fully adjustable, wiring instructions, complete in metal case. Price 3/6, post 9d.

**DYNAMOS**, all shunt wound and fully guaranteed, 50/75 v.-15 a., 26/10/-; 50/75 v.-25 a., 28/10/-.

**25-VOLT D.C. MOTOR**, maker "Crompton," 1/2 h.p., ball bearing, in perfect order, 23, carriage forward.

**DITTO**, on iron bedplate, but fitted with large reduction gear and rope drum, 25, carriage forward.

**110-VOLT D.C. MOTOR**, totally enclosed, rated at 8 amps., ball bearing, in new condition, make good slow-speed dynamo, 22/5/-, carriage forward.

**GUNMETAL PULLEYS**, 7in. diameter, to take 1in. dia. rope, complete with rope guard and hook, 7/6 each, post free.

**PHILLIPS TRANSFORMERS**, 220 v. input, output 2,000-0-2,000 volts, 200 m/a and 2 L.T.s., 50/-, carriage forward.

**2 kW TRANSFORMER CORES** for rewinding, sound windings but rating unknown, 20/- each, carriage forward.

**1/2 HP 110 v. D.C. MOTOR**, in good working order, 25/-, carriage forward.

**SLIDER RESISTANCE**, 2,500 ohms at 200 m/a, worm and wheel control, 25/-, post free.

**MILLIAMPMETERS**, 2in. dia. 0-30 m/a, 20/-; 2 1/2in. dia. 0-500 m/a, 20/-.

**PORTABLE VOLTMETER**, 0-500v. moving coil, 5 1/2in. scale, 50/-.

**EPOCH 20-WATT SPEAKERS**, 6-volt field, 45/-.

**FLOODLIGHTS**, 12in. dia., multi mirror type with 5in. dia. margin spot centre, any bulb can be fitted, 15/-.

**AERO DYNAMOS**, output 12v.-12 amps., new, 15/- each. Carriage 2/6.

**PRESS-BUTTON UNITS**, 8-way, 7 x 6 x 1 1/2 ins., fitted capacitors, condensers, etc. Price 5/6, post free.

**1 kW AUTO TRANSFORMER CORE** for rewinding, complete with clamps and bobbin. Price 12/6, carriage paid.

**ULTRA SHORT SILVER SPRAY CONDENSERS**, wire ends, all new, assorted from 15 to 600 MMF. our assortment 7/6 doz., post free.

**IDEAL!**

For Gramophone or Microphone use in the Home, Office or Factory,  
**This Modern 5-watt, 4-Valve 220-volt A.C. AMPLIFIER CHASSIS** is an outstanding bargain.

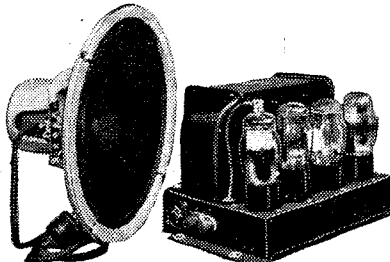

**4 VALVE 5 WATT AMPLIFIERS** for 220-250 A.C. Streamline shock-proof chassis, 2 triodes output stage with super 10in. energised M/C speaker, special output transformer and volume control. Limited number only. 6 gns. complete.

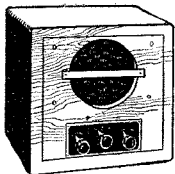

**GRAMOPHONE AMPLIFIERS** for A.C. 220-250 v. 3 valves 3 watt Pentode output 3 position tone control, in polished mahogany cabinet 14in. x 14in. High class P.M. Loud-speaker enclosed. Only 30 available. 5 gns. complete with valves—a really super article.

**PHILIPS 6 VALVE A.C. AMPLIFIERS** for 110-250 v. A.C. 40-50 watt output, super job, built for Government. 6 only, complete. £17/10/-.

**HORN TYPE PROJECTION LOUD-SPEAKER** 6in. super P.M. unit. Aluminium horn 42in. long, 32in. diameter flare, ideal for large factory, etc. Impedance 20 ohms. £8/10/-.

**MICROPHONES:** Heavy duty, double button type. Chromium-plated case. Gold plated electrodes. High output. Good quality. With mounting clips and springs, complete with Transformer, 30/-.

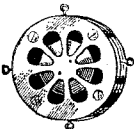

**AUDAK PICK-UP HEADS.** High resistance coil, 6/6.

**AUDAK CUTTING HEADS** (Heavy Duty) 3-5 ohm coil. High quality instrument, 17/6.

**SINGLE EARPIECES,** with flexible metal sheathing, chrome plated, 2/6.

**ELECTRO-MAGNETIC COUNTERS.** Resistance 500 ohms, counting from 1 to 12,999, 9/6. Smaller Type, 1 to 1999, 5/6. Useful for innumerable purposes.

**WESTINGHOUSE RECTIFIERS.** Type H.T.8, slightly used. Guaranteed O.K., 8/6.

**COMPLETE MOTOR-DRIVE TUNING ASSEMBLY,** including 2-gang .0005 condenser, tuning motor with muting switch and homing commutator and station selector. With 8-Button push-button switch, 25/- . Full details supplied.

**SMALL REVERSIBLE A.C. MOTORS** (as used for motor tuning). 25-30 volts A.C. Built-in reduction gear spindle. Speed about 60 r.p.m. A first-class job with hundreds of applications, 8/6.

**TAPPED MAINS RESISTANCES** for .2 amp-valves tapped 200, 230-250, 4/-.

**ASSORTED RESISTANCES.** Erie, etc., our selection 1/6 doz.

**3-WAY, 4-POLE SWITCHES.** Rotary type, 1/6 each.

**LONDON CENTRAL RADIO STORES**  
 23, LISLE STREET, LONDON, W.C.2

Phone: GERrard 2969

**COMPONENTS—SECOND-HAND, CLEARANCE, SURPLUS, ETC.**

RADIO CLEARANCE, Ltd.

**P**LESSEY 4 Waveband Coil Units, with switching, fully screened Pre H.F. stage, 465 k/c. oscillator 13 metres, 2,000 metres, 21/- each; I.F. transformers, 2/6 each extra; gang condensers for same, 2/11.

**L**ISSEN 2v. Battery Pentodes, 4-pin, side terminals, P.T.2A.; 4/11 each.

**L**ISSEN Rectifier Valve, U650; 2/11 each.

**L**OW-LOSS Ceramic Valve Holders, Lissen Hi-Q baseboard and chassis, 7-pin; 1/- each.

**L**OW-LOSS Short-wave Condensers, variable, ceramic insulation, brass vanes, Lissen Hi-Q, minimum capacity 5 microfarads, 20 mfd., list 5/6 each; our price, 2/6 each.

**P**USH-PULL Switch, Lissen 2-point, 4d. each; 3-point, 6d. each.

**Y**AXLEY Type Switches, 4-pole, 3-way; 9d. each.

**Y**AXLEY Switches, 4-bank, 2-pole, 4-way; 2/6 each.

**Y**AXLEY Switches, 6-bank; 3/- each.

**Y**AXLEY Switches, 9-bank; 3/6 each.

**A**MERICAN Line Cords, with fittings; 3/6 each.

**R**OLA P.M. Speakers, latest model, 7 1/2 in. cone, with power and pentode transformer, boxed; 15/- each.

**M**AGNAVOX 10in. Energised Speaker, field resistance, 3,000 ohms; 12/6 each.

**C**LOCK-FACED Dials, 5in. x 5in., with printed scale, 4-wave; 2/6 each.

**S**TRAIGHT-LINE 3-waveband Dials; 1/11 each.

**M**AINS Transformers, G.E.C. American windings, 350-0-350v. 65 m.a., 5v. 2 amps, 6.5v. 3 amps, suitable for replacements in G.E.C. models; 6/6 each.

**M**AINS Transformers.—Wearite R.C.1 250-0-250v. 80 m.a., 4v. 2.5 amps., 4v. 4 amps., 9/11 each; R.C.2 350-0-350v. 120 m.a., 4v. 2.5 amps., 4v. 4 amps., 12/6 each; R.C.3 350-0-350v. 150 m.a., 4v. 2.5 amps., 4v. 2 amps., 4v. 5 amps., 15/- each; R.C.4 500-0-500v. 150 m.a., 4v. 2 amps., 4v. 2.5 amps., 4v. 5.6 amps., 21/- each; R.C.5 100-watt auto-transformers, 100-110v., 200-250v. reversible, 14/11 each; all above transformers 200-250v. tapped primaries; R.C.D. drop-through type, capped, 350-350v. 100 m.a., 5v. 2 amps., 6.5v. 5 amps., 10/8 each.

**C**HASSIS Mounting Valve Holders, American 4.5-6 pin, 4d. each; Octals, 6d. each.

**C**HASSIS Mounting Valve Holders, English Chix type, 4.5-7-pin, 3d. each; Celestion valve holders, 5- and 7-pin chassis type, 4d. each; baseboard type, 5-pin, 2d. each.

**C**ENTRALAB Volume Controls, Midget type, 2,000, 5,000, 25,000, 50,000, 100,000, 500,000 ohms, less switch, 2/9 each; 1,000, 25,000, with switch, 3/6 each.

**S**PEAKER Transformers, pentode output; 3/6 each.

**P**RESS Button Units, size of unit 6in. x 6in. x 2in., complete with 6 press buttons and capacitors; 4/11 each.

**P**LESSEY Motor Tuning Units, including fractional h.p. A.C. motor for 12v. continual running on 24v., intermittent running and 2-gang 0.0005 condenser; 8/6 each.

**12-WAY** Push-button Switches, 1/6 each; 11-way push-button switches, 1/6 each; 6-way push-button switches, 1/- each; 7-way push-button switches, 1/4 each.

**S**PEAKER Cabinets, suitable for 8in. speaker; 4/6 each.

**D**RIPPING Resistances, for all purposes, total resistance 535 ohms., 5 taps in steps of 50 ohms., standard for Pye, Lissen, Eyer Ready, etc.; 3/- each.

**R**ESISTANCES, 100 ohms., 10 watt; 1/- each.

**10 FT.** Coils Connecting Wire, glazed; 4d. each.

**D**UAL Capacitors, 300 x 600; 4d. each.

**C**OILS Kits, for superhet circuit, including 2-gang straight condensers, aerial coil assembly, oscillator coil assembly and 2,465 k/c. I.F. transformers, with circuit diagram; 8/11 each.

**P**USH-ON Pilot Lampholders; 3d. each.

**P**LESSEY Single-gang 0.0005 Variable Condensers; 1/6 each.

**P**ERMUABILITY Tuned Press Button Units; 2/6 each.

**B.I.** Wire-end Bias Electrolytics 50 mfd., 12v.; 1/6 each.

**B.I.** Bias Condensers, 50 mfd., 50v.; 2/11 each.

**T**UBULARS, wire end non-inductive paper condensers, all sizes up to 0.01, 5d. each; 0.1, 7d. each

**B.I.** 8 mfd. Tubular Cartons; 2/11 each.

**T**O.C. 2 mfd. Electrolytic Condensers, 200v. working; 1/3.

**H**UNTS 8x8 mfd. Electrolytic Condensers, 700v. peak; 5/- each.

**C**LAN Electrolytics, 12x16 mfd., 525v. peak, with clip fitting; 3/11 each.

(Continued on next page.)

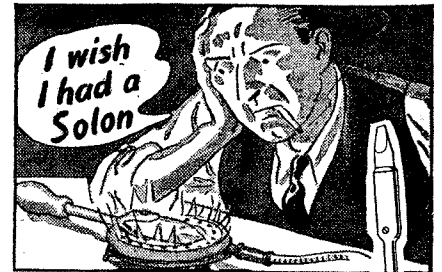

**The SOLON saves time & trouble**

No waiting for re-heating with the Solon! Once hot (and that takes only 4 minutes) it stays hot! 15 hours continuous soldering uses only 1 unit. That's why Solon Electric Soldering is better, neater, stronger, and far easier. Get a Solon and do the job properly!



Made for the following standard voltages:—200/220, 230/250.



Handyman model supplied complete with Resin-Cored Solder, Flex and Lamp Adaptor **9/4**  
 Solon Resin-Cored Solder **6d.** per reel.

**W. T. HENLEY'S TELEGRAPH WORKS CO. LTD.**  
 (Dept. 22/E), Engineering Sales Dept., Milton Court, Westcott, Dorking, Surrey.

**Joining the R.A.F.?**

**ARMY—NAVY—MERCANTILE MARINE OR TAKING UP WORK OF NATIONAL IMPORTANCE** in which a thorough knowledge of the Morse Code is essential for becoming a skilled W/T operator? Then investigate the proved Candler method of

**MORSE CODE TRAINING**

There are courses for beginners and operators.

**CANDLER CODE COURSES**

have for many years been responsible for the training of thousands of skilled W/T operators who now hold important positions in the Services, Commercial Companies and the Mercantile Marine. Why not fill in the Coupon and learn more about this remarkably efficient Candler method of Code training in your own home.

The JUNIOR Scientific Code Course is for beginners. It teaches all the necessary code fundamentals scientifically. The ADVANCED and High-Speed Telegraphing Course is for operators who want to increase their w.p.m. speed and improve their technique.

The TELEGRAPH Touch-Type Writing Course is for those who want to become expert in the use of the typewriter for recording messages.

Courses supplied on Cash or Monthly Payment terms.

**COUPON**

Please send me a Free Copy of Candler "Book of Facts."

NAME.....  
 ADDRESS.....

Post Coupon in 1d. unsealed envelope to London Manager

**CANDLER SYSTEM CO. (55.W.),**  
 121, Kingsway, London, W.C.2.  
 Candler System Co., Asheville, North Carolina, U.S.A.



COMPONENTS—SECOND-HAND, CLEARANCE, SURPLUS, ETC.

(Continued from previous page.)

- CAN Electrolytics, 8x8 mid., 450v. working. with clip fitting; 3/11 each.
- T.C.C. 1x1 Mid. Paper Condenser, 250v. A.C. working, 450v. D.C. working; 1/11 each.
- T.C.C. 1 Mid. Paper Condensers, 350v. working; 1/- each.
- CONDENSERS, 0.0005 twin, 1/3 each; triple, 1/9 each.
- WESTON Metres, 0.50 m.a. and 0.300 m.a., moving coil type; 25/- each.
- ROTHERMEL Senior Crystal Pick-ups; 32/6 each.
- DOUBLE Fuse Holders Complete with Two 1in. Fuses; 1/6 each.
- SMALL Brown Knobs; 2d. each.

WE Have in Stock a Large Selection of High Voltage Paper Condensers, all capacities but too numerous to advertise. Advise interested clients to call.

ALSO Large Selection of High Voltage Transmitters and Chokes.

RAYTHEON Valves, first grade, largest stockists, all types stocked, including glass series, glass Octal series, metal series, bantam series, single-ended metal series and resistance tubes; all at most competitive prices; send for valve list.

ALL Orders Must Include Sufficient Postage to Cover. Hours of business: Week-days, 9-4. Saturdays, 9-1 p.m. Please write your name in block letters. We cannot undertake to answer enquiries unless full postage included (2½d.).

RADIO CLEARANCE, Ltd., 95, High Holborn, London, W.C.1. Phone: Holborn 4561. [9483]

PREMIER RADIO.

PLEASE See Our Displayed Advertisement on page 5. [0488]

SOUTHERN RADIO'S Wireless Bargains.

ALL Goods Previously Advertised Still Available.

SOUTHERN RADIO, 46, Lisle St., London, W.C. Gerrard 6653. [9258]

RADIOLAB and Small Quantity Components.—King, Post Office, Langton Green, Tunbridge Wells. [9471]

SOILED 33/- Rothermel Crystal Pickup Heads; offers?—Felix, 2, Bedwardine, Upper Norwood, S.E.19. [9482]

KIT of Parts for Battery Charger, charges from 2v. to 12v., 26/-; High Fidelity crystal pick-up heads, ft. tone arm of gramophone in place of sound box, 23/6; crystal mikes, famous maker, 52/6; Type 80 tubes Continental firsts, 4/9, postage 3d.—Champion, 42, Howitt Rd., London, N.W.3. [9485]

COULPHONE RADIO. New Longton, Preston.—Prompt personal service. Brand new goods. Large stocks Tungstram valves. American (guaranteed) valves, including metal and midget types, 5/9 to 7/6. Cosmocord Series III Crystal Pick-ups, 23/6. Latest type speakers, with transformers, 10in. Rola P.M., 22/6. 8in. Goodman's C/810, at 17/6. Electric AC DC 110/250 Dryshavers, 22/6. Electrolytics 8+8 mfd. 500v. (4 leads), 4/3; 8 mfd. 500v., 2/6; 50 mfd. 50v., 2/6. Erie and Dubilier 1 watt resistors, all values, 5/6 dozen. Stamp for New 1941 (Spring) List. [9467]

METERS, ETC.

UNIVERSAL Avometer, almost new, perfect condition; accept £10, or near offer.—Particulars, Jeffers, 9, Market St., Portadown, Northern Ireland. [9465]

TEST EQUIPMENT Wanted

AVO All-wave Oscillator, or other good make.—Tregunna, High Cross St., St. Austell. [9481]

SERVICE OSCILLATOR, moderate price.—Smetzer, 312, Du Cane Court, London, S.W.17. [9488]

TUITION

RADIO Training.—P.M.G. exams. and I.E.E. Diploma; prospectus free.—Technical College, Hull. [0611]

MORSE Code Courses.—"Book of Facts," free.—Candler System Co. (Room 55 WO), 121, Kingsway, London, W.C.2. [9074]

PRACTICAL Postal Courses, radio television, test equipment design, trade-test coaching for R.A.F. post, I.P.R.E. and I.W.T. exams; booklet free.—Secretary, I.P.R.E., Bush House, Walton Av., Henley-on-Thames. [9328]

RADIO Engineering, Television and Wireless Telegraphy; comprehensive postal courses of instruction.—Apply British School of Telegraphy, Ltd., 179, Clapham Rd., London, S.W.9 (Estd. 1906). Also instruction at school in wireless for H.M. Merchant Navy and R.A.F. [9249]

These TAX-FREE SHELTER COMFORTS will keep you dry and warm.

'Stuart' Centrifugal Electric SHELTER PUMP

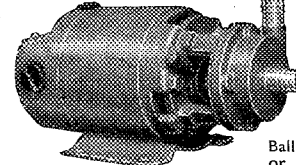

Quickly clears water from shelters. Ideal for many other A.R.P. uses. A sound job built for continuous running.

Delivery from stock. Ball bearing motor, A.C. or D.C., any voltage.

Low current consumption. Will lift water up to 35 feet below ground level. Connections for rubber hose. All parts non-rusting.

No. 10, 100 galls. per hour, £4.10. No. 11, 280 galls., £5.12.0. No. 12, 560 galls., £6.15.0. Foot valve and strainer (for over 5 ft. lift) 12/- and 14/6 extra.

MORPHY-RICHARDS ELECTRIC FIRES

- Tubular Major, 1 kW ... .. 1 7 6
- Tubular Twin Beam, 1 or 2 kW ... 1 16 0
- Cray Twin Beam, 1 or 1½ kW ... 1 1 0
- Senior Twin Beam, 1 or 2 kW ... 1 7 6

A few Electric Irons also available.

BARGAINS

DAVENSET Charger, as new, with unused Rectifying Valve and Barretters, charges up to 12 v. at 3-4 amps., £8. Sound Sales, Dual Suspension Super Auditorium Speaker, little used, £7. Heavy Energising Unit, £5. A first class P.A. speaker.

SPECIAL OFFER.

GENT'S FOB WATCH with neat stand. For use in pocket or on desk. Luminous dial. Excellent Swiss movement. Tax-free. Money back guarantee, 21/-. Send 2½d. stamp for illustrated price lists of any item. Terms: Cash with order or C.O.D.

LONDON RADIO SUPPLY CO.

Established 1925

All communications to evacuation address—

"WINDEN," ARDINGLY RD., BALCOMBE, SUSSEX

THE INSTITUTE OF WIRELESS TECHNOLOGY

(Founded in 1925. Incorporated 1932)

PROFESSIONAL MEMBERSHIP

The advantages of professional membership are open to all qualified wireless engineers.

Full information, with syllabus, may be obtained from the Assistant Secretary, Institute of Wireless Technology, 25, Firs Drive, Palmers Green, London, N.13. Phone: PALMERS GREEN 2413

ENGINEERING OPPORTUNITIES

This unique Handbook shows the easy way to secure A. M. I. C. E., A. M. I. Mech. E., A.M.I.E.E., A.M.I.A.E., A. M. I. W. T., A.M.I.R.E., and similar qualifications. WE GUARANTEE—NO PASS—NO FEE. Details are given of over 150 Diploma Courses in all branches of Civil, Mech., Elec., Motor, Aero, Radio and Production Engineering, Draughtsmanship, Tracing, Inspection, Government Employment, BUILDING (the great after-war career), R.A.F. MATHEMATICS, etc. Write for this enlightening Handbook to-day. FREE and post free. Men with Radio knowledge can obtain attractive posts in the Services. BRITISH INSTITUTE OF ENGINEERING TECHNOLOGY, 387 Shakespeare House, 17, 18, 19 Stratford Place, London, W.1

CLASSIFIED ADVERTISEMENTS

intended for the MAY ISSUE can be accepted up to

Tuesday, April 8th.

REPAIRS AND SERVICE

12-40 Tube Receiver Service.

TECHNICAL Specialists for Scott, Mid-West, Majestic, and all multi-valve receivers.

R.A. RADIO SERVICE, 62, The Broadway, Mill Hill, London, N.W.7. Mill Hill 4313. [9475]

L.T.P. (LONDON TRANSFORMER PRODUCTS, Ltd.), Willesden, N.W.10. Willesden 6486 (3 lines). [9227]

EPOCH. Epoch.—Genuine replacement diaphragms for all models, Domino, Supercinema, etc., guaranteed 12 months.—"R.E.C.S.," Crown St., Reading. Phone: 2795. [9478]

MAINS Transformer Service, repairs, rewinds, or construction to specification of any type, competitive prices and prompt service.—Sturdy Electric Co., Dipton, Newcastle-on-Tyne. [0516]

"SERVICE with a Smile."—Repairers of all types of British and American receivers; coil rewinds; American valves, spares, line cords.—F.R.I., Ltd., 22, Howland St., W.1. Museum 5675. [8934]

METROPOLITAN RADIO SERVICE.—Guaranteed repairs to American and British receivers; linecord resistances, Majestic I.P. transformers, and rewinds; trade supplied.—1021, Finchley Rd., N.W.11. Speedwell 3000. [0435]

SITUATIONS VACANT

AIR MINISTRY.

CIVILIAN W/T. Operators Required, age 21 to 45, preferably with 1st Class P.M.G. or Air Operator's Certificate in Wireless Telegraphy, and experience in Radiotelephony, Direction Finding and Wireless Maintenance work.

SALARY 75/- a week, rising to 125/- a week, plus a temporary war bonus of 5/- a week on the earlier points of the scale.

APPLY by postcard for Application Form and full particulars to the Under-Secretary of State, Air Ministry (S.1(e)), Julian Rd., Bristol. 9. [9420]

SENIOR Radio Service Engineer; give references, wage, age.—Watson's, Peak Buildings, Buxton. [9473]

(Small advertisements continued overleaf.)



FOR THE

RADIO SERVICE MAN, DEALER AND OWNER

The man who enrolls for an I. C. S. Radio Course learns radio thoroughly, completely, practically. When he earns his diploma, he will KNOW radio. We are not content merely to teach the principles of radio, we want to show our students how to apply that training in practical, every-day, radio service work. We train them to be successful!

INTERNATIONAL CORRESPONDENCE SCHOOLS

Dept. 38, International Buildings, Kingsway, London, W.C.2.

Please explain fully about your Instruction in the subject marked X.

Complete Radio Engineering Radio Service Engineers

Elementary Radio Television

If you wish to pass a Radio examination, indicate it below.

Inst. of Wireless Technology P.M.G. Certificate for Wireless Operators Provisional Certificate in Radio Telegraphy and Telegraphy for Aircraft City and Guilds Telecommunications

Name ..... Age ..... Address .....

(Use penny stamp on unsealed envelope.)

**SITUATIONS VACANT**

**R**ADIO Communication Equipment.

**E**. K. COLE, Ltd., require young men, 18-22 years. For a paid Training Scheme covering production and test. Hostel available.

**A**PPlicants should be of Higher School or School Certificate standard with 2 years' subsequent technical works or scientific training. Persons who are in work should state particulars of their present employment.—Application must be made by letter, addressed to The Manager, Employment Exchange, Swindon, and not to the firm. [9462]

**L**ABORATORY Assistant, Junior, Required; good opportunity for youth to obtain useful training and, practical experience.—Goodmans Industries, Ltd., Lancelot Rd., Wembley. [9466]

**R**ADIO Service Engineer, over military age, required immediately; London; experience in all types of sets imperative.—Write, stating age, experience, and salary required, to Box 2568, c/o *The Wireless World*. [9460]

**W**ANTED—Civilian Wireless Instructors (male) at R.A.F. Signals Schools—£5/2/6 weekly, rising annually by 2/6 to £5/10. Sound knowledge of electrical principles and their application to radio and low power electrical engineering essential. Test for candidates will include giving lecture on any subject they choose involving principles of modern radio. Lecturing sequence and style most important. Minimum age 30.

**A**PPLY, in writing, Air Ministry (S.5D.), W.C.2. with particulars of experience, age, etc. Third class fares repaid to candidates required to attend Selection Boards [9349]

**PRINTING**

**E**NVELOPE Reseal Labels, 100 1/3, 500 4/-, 1,000 7/6.—Hoigson, Printer, Bradford, [9464]

**TECHNICAL TRAINING**

**G**REAT Possibilities Exist for Technically Qualified Engineers, key men in wartime and afterwards. Through the home-study courses of The T.I.G.B. take a recognised engineering qualification such as A.M.I.Mech.E., A.M.I.E.E., A.M.I.R.E., A.F.R.Ae.S., A.M.I.Chem.E., C. and G., etc., in which examinations the T.I.G.B. students have gained 25 **FIRST PLACES** and Hundreds of Passes. Write to-day for "The Engineer's Guide to Success"—Free—containing the world's widest choice of engineering courses covering all branches, including Aeronautical, Mechanical, Electrical, Wireless, Chemical, etc.

**T**HE TECHNOLOGICAL INSTITUTE OF GREAT BRITAIN, 82, Temple Bar House, London, E.C.4. [9355]

**MORSE EQUIPMENT Wanted**

**W**ANTED, set of Morse records by Masters; also A.C. radio-gram. unit with pick-up.—79, Allessley Old Rd., Coventry. [9474]

**BUSINESSES AND PROPERTY FOR SALE, TO BE LET, OR WANTED**

**"T**he Wireless and Electrical Trader" is an essential part of the equipment of every Wireless Trader; its pages reflect the very latest turn of trade events, and it is read by all the leading dealers and manufacturers, for particulars of businesses offered or wanted. By subscription, to the trade only, 17/6 per annum, post free.—Send your trade card for specimen copy to Dorset House, Stamford St., London, S.E.1. [0614]

**VACUUM CLEANERS**

**H**OOVER, £10/10; Electrolux, £8/8; Tellus, £5/5; Hotpoints, Goblins, Vactrics, and many others from £3/3; every model rebuilt and fully guaranteed.—"R.E.C.S.", Crown St., Reading. Phone: 2796. Exchanges. We buy Hoovers. [9479]

**BOOKS, INSTRUCTIONS, ETC.**

**E**VERY Radio Dealer Who is Not a Regular Reader of "The Wireless and Electrical Trader" should send his trade card at once for a specimen copy and full details of the "Trader" Services. The Wireless and Electrical Trader has the widest influence, and is read by all the leading manufacturers and traders. Trade only, 17/6 per annum, post free. Published at Dorset House, Stamford St., London, S.E.1. [0615]



Mains Transformers to customers' own specifications, or in accordance with our standard list—of which we would be glad to send you a copy.

Westmoreland Road, London, N.W.9  
Telephone: Colindale 7131.

**THE SIMMONDS GROUP OF COMPANIES**

**INVENTORS**

We continually seek new inventions and products in all branches of industry for development and production by the manufacturing Companies of the Simmonds Group throughout the world.

**SIMMONDS DEVELOPMENT CORPORATION LIMITED**  
BUSH HOUSE, ALDWYCH, W.C.2.

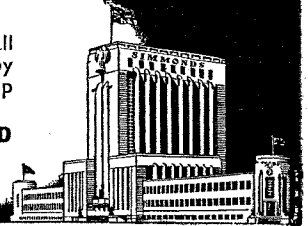

Why leave your speaker at home?

Our 2ft. MOUTH HORN is ideal for limited space, for speech, for compactness. Can be unbolted for packing.

From stock—ex works

Price £4 - 16 - 3.

UNIT WITH TWIN DIAPHRAGM.....£15 - 15 - 0

(about 40 watts required for full excitation)

**VOIGT PATENTS LIMITED**

The Courts, Silverdale, Sydenham, S.E.26  
Telephone SYDenham 6666

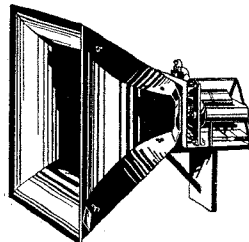

**SPECIAL OFFER OF**

**AUTOMATIC MORSE CODE SENDERS**

(Patented). These instruments are indispensable for the rapid learning of the Morse Code. No practice or preparation is necessary for anyone—even a child—to send immediately in any order, perfect Morse signals at speeds from 5-30 w.p.m. Replaces ordinary key for operating buzzer, oscillator, etc. International Code (41 characters).

Unassembled, with full instructions for constructing, 4/6; only baseboard (no special type) required extra. Instrument complete on baseboard, 6/6. Superior 2-6 volt Buzzers, 2/6. Plated brass Morse tapping keys, ebonite knob, for baseboard mounting, 6d. All goods post-paid.



**MIDLAND INSTRUMENT CO.**  
74, GOSFORD STREET, COVENTRY.

**INCREASED PRODUCTION FACILITIES**

Arrangements have now been completed whereby our pre-war delivery rate of Special Transformers (per return in the case of small quantities and large quantities correspondingly prompt) has again been achieved. This special service is strictly reserved for Urgent Government Work and the Government Contract number for which the goods are required must be quoted when ordering.

**N. PARTRIDGE, B.Sc., A.M.I.E.E.**

King's Buildings, Dean Stanley Street, London, S.W.1  
Telephone: VICToria 5035.

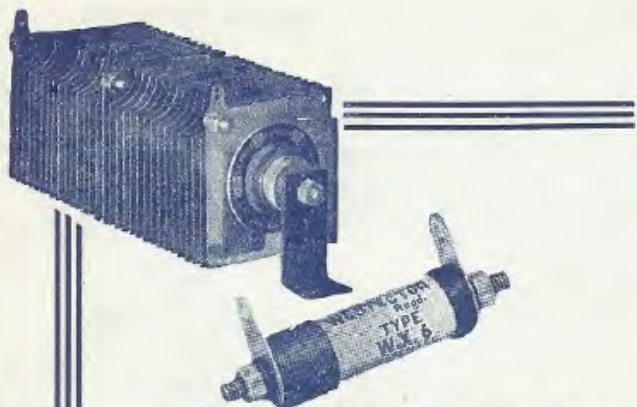

**ECONOMICAL**  
in use—as reliable as the tide  
*Westinghouse*  
METAL  
**RECTIFIERS**

Never need replacing and their use, either in battery or mains receivers, cuts down the power consumption of the set. Send 3d. to Dept. W.W. for a copy of "The All Metal Way."

WESTINGHOUSE BRAKE & SIGNAL Co. Ltd., Pew Hill House, Chippenham, Wilts.



**Cheerfulness**

When cheerfulness is in danger of disturbance, light a 'Player,' and with a few 'puffs' put trouble in its proper place. The friendly Sailor, as always, stands for cheery contentment and a guarantee that quality and purity remain unchanged.

KEEP THAT HAPPY EXPRESSION

*Player's Please*



N.C.C. 5476

**ROLA**

LOUD  
**SPEAKERS**

THE WORLD'S FINEST REPRODUCERS

TRANSFORMER  
**LAMINATIONS**

Core Width  $\frac{3}{8}$ " to  $1\frac{1}{2}$ " (E's & I's)

EIGHT STOCK SIZES

A Comprehensive Bulletin together with details of Associated Covers and Clamps with design data will be sent to manufacturers on request.

**BRITISH ROLA LIMITED**

MINERVA RD., PARK ROYAL, N.W.10. WILlesden 4322



**MUSIC**

**WHERE YOU WANT IT...**

Have you joined that rapidly increasing number of "listeners" to the new radio pleasure: "Music where you want it"?

Free from the restrictions of one-room radio, they are enjoying their favourite programmes in the shelter, whilst working in the kitchen, or wherever it is convenient to listen; and all by the simple connection of a Stentorian Extension speaker to their existing radio. What's more, these handsome, but moderately priced speakers offer an appreciable improvement in reproduction over most built-in speakers. Why not make full use of your radio NOW by installing a Stentorian? Ask your local dealer for a demonstration.



Cabinet  
Models for 21/8



**Stentorian**

THE PERFECT EXTRA SPEAKER FOR ANY SET

WHITELEY ELECTRICAL RADIO CO. LTD., MANSFIELD, NOTTS

95 h/m

# FREQUENTITE

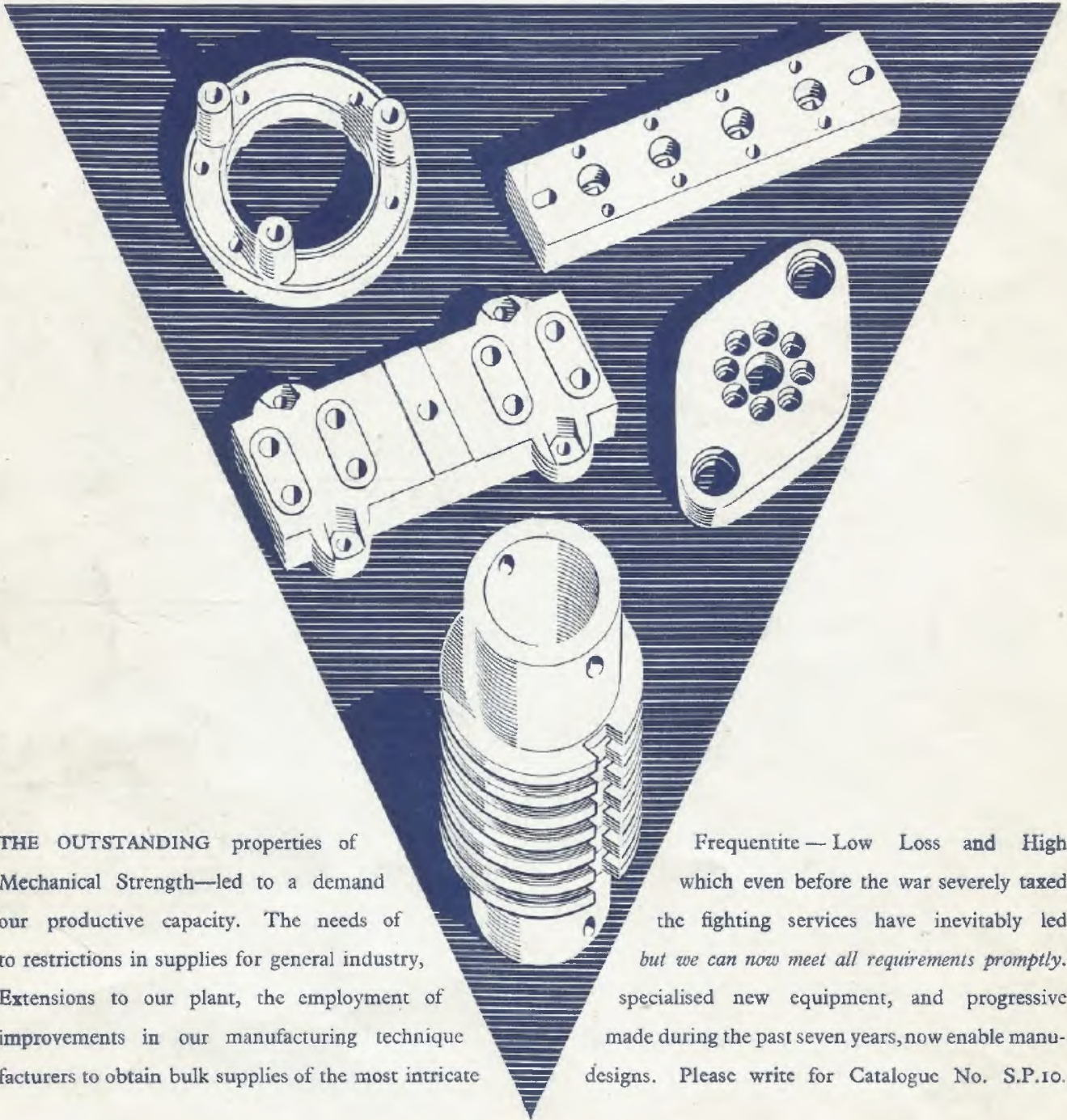

THE OUTSTANDING properties of Mechanical Strength—led to a demand our productive capacity. The needs of to restrictions in supplies for general industry, Extensions to our plant, the employment of improvements in our manufacturing technique factors to obtain bulk supplies of the most intricate

Frequentite — Low Loss and High which even before the war severely taxed the fighting services have inevitably led *but we can now meet all requirements promptly.* specialised new equipment, and progressive made during the past seven years, now enable manu- designs. Please write for Catalogue No. S.P.10.

## STEATITE & PORCELAIN PRODUCTS LTD.

*Pioneer Manufacturers of British Low Loss Ceramics*

Head Office and Works :

STOURPORT - ON - SEVERN, WORCS.

Telephone: Stourport 111.

Telegrams: Steatite, Stourport.

SP.3